



Raritan PX

Quick Setup Guide

Thank you for purchasing the Raritan PX intelligent power distribution unit (PDU). The intended use of the Raritan PX is distribution of power to information technology equipment such as computers and communication equipment where such equipment is typically mounted in an equipment rack located in an information technology equipment room.

This Quick Setup Guide explains how to install and configure the PX. For further details on using the PX, access online help from the application, or download the user guide from the Raritan website's **Support page** (<http://www.raritan.com/support/>). For more detailed information on this release, see the latest release notes on the Support page.

Safety Precautions

WARNING! Read and understand all sections in this guide before installing or operating this product. Failure to heed any of the following WARNINGS may result in electric shock, fire, personal injury and death. Prior to operating this product, the user should read the online help and specifically the warnings in the online help.

WARNING! Connect this product to an AC power source whose voltage is within the range specified on the product's nameplate.

WARNING! Connect this product to an AC power source that is current limited by a suitably rated fuse or circuit breaker in accordance with national and local electrical codes.

WARNING! Use this product in a dry location.

WARNING! Connect this product to a protective earth ground. Never use a "ground lift adaptor" between the product's plug and the wall receptacle.

WARNING! If this product is a model that requires assembly of its line cord or plug, all such assembly must be performed by a licensed electrician and the line cord or plugs used must be suitably rated based on the product's nameplate ratings and national and local electrical codes.

Unpacking the PX

The PX comes in Zero U, 1U, and 2U sizes. The following describes the equipment shipped with each size. Unpack the components. If any pieces are missing or damaged, report this to Raritan Technical Support at tech@raritan.com, or contact the Raritan partner where you purchased the product.

Zero U Size

- The PX device
- Mounting screws, brackets and/or buttons
- A null-modem cable with DB9 connectors on both ends (Raritan number: 254-01-0006-00) (optional)
- Cable retention clips for the inlet and/or outlets (for some models only)

1U and 2U Size

- The PX device
- 1U or 2U bracket pack and screws
- A null-modem cable with DB9 connectors on both ends (Raritan number: 254-01-0006-00) (optional)
- Cable retention clips for the inlet (for some models only)

Before You Begin

1. Prepare the installation site. Make sure the installation area is clean and not exposed to extreme temperatures or humidity. Allow sufficient space around the device for cabling and outlet connections. Safety instructions are provided in the PX Online Help.
2. Fill out the Equipment Setup Worksheet found in the PX Online Help. Record the model, serial number, and use of each IT device connected to the PDU's power outlets.

Mounting the PX

Use one of the mounting methods to install your PX device as appropriate.

Circuit Breaker Orientation Limitation

Usually a PDU can be mounted in any orientation. However, when mounting a PDU with circuit breakers, you must obey these rules:

- Circuit breakers CANNOT face down. For example, do not horizontally mount a Zero U PDU with circuit breakers on the ceiling.
- If a rack is subject to shock in environments such as boats or airplanes, the PDU CANNOT be mounted upside down. If installed upside down, shock stress reduces the trip point by 10%.

Note: If normally the line cord is down, upside down means the line cord is up.

Mounting 1U or 2U Models

Using the appropriate brackets and tools, fasten the 1U or 2U PX device to the rack or cabinet.

► To mount the PX device:

1. Attach a rackmount bracket to both sides of the PX with the provided screws.

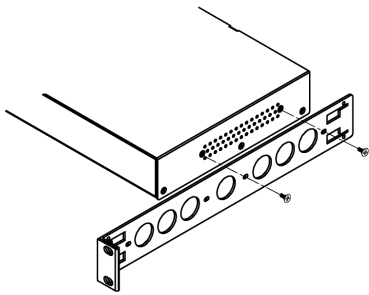

2. Insert the cable-support bar into rackmount brackets.

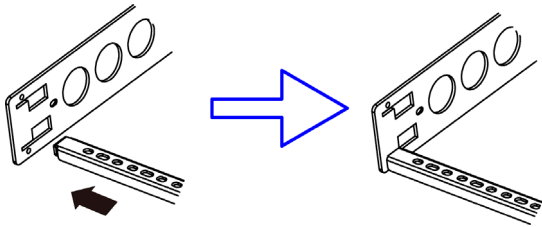

3. Secure with the provided end cap screws.

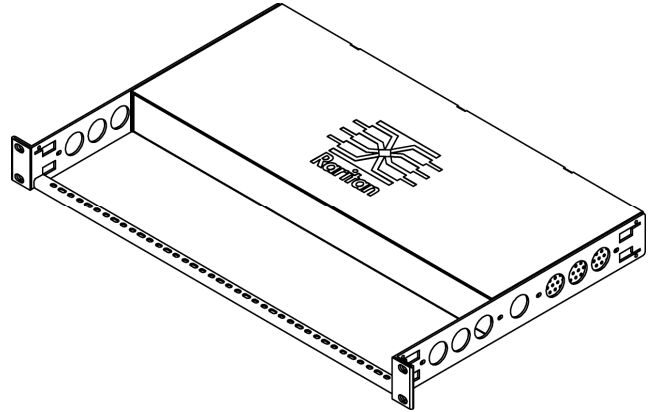
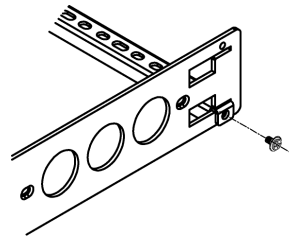

4. Fasten the rackmount brackets' ears to the rack using your own fasteners.

Mounting Zero U Models Using Baseplate-Based Tools

You can use one of the three baseplate-based tools to mount the PDU: L-brackets, buttons or claw-foot brackets.

► To mount Zero U models using baseplates:

1. Align the baseplates on the rear of the PX device.
2. Make the baseplates grasp the PX device lightly. Use the included L-shaped hex key to loosen the hex socket screws until the baseplate is "slightly" fastened.

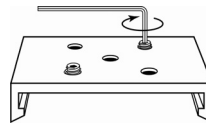

3. Attach brackets or buttons to the baseplates.
 - Fasten each L-bracket or claw-foot bracket to each baseplate with at least three screws (one through each slot).

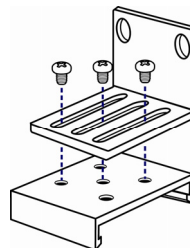

OR

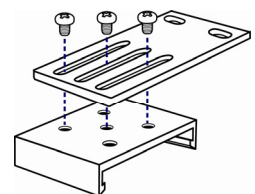

- Screw each mounting button to each baseplate. The recommended torque for the button is 1.96 N·m (20 kgf·cm).

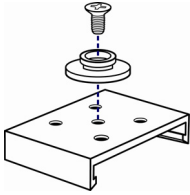

4. Fasten the PX device to the rack or cabinet using the baseplate-based tools.
 - Use rack screws to fasten L-brackets or claw-foot brackets on the PDU to the rack.
 - For the buttons, press the PDU forward, pushing the mounting buttons through the mounting holes, then letting the device drop about 5/8".

Mounting Zero U Models Using Buttons

1. Turn to the rear of the PDU.
2. Locate the two screw holes on the rear panel.
3. Screw a button in each screw hole. The recommended torque for the button is 1.96 N·m (20 kgf·cm).

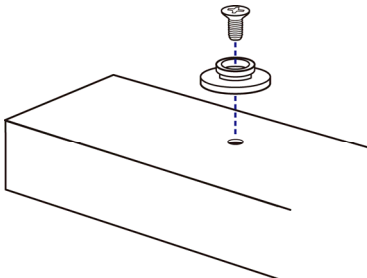

4. Press the PX device forward, pushing the mounting buttons through the mounting holes, then letting the device drop slightly.

Mounting Zero U Models Using L-Brackets and Buttons

1. Fasten the L-bracket to each end of the PX device.

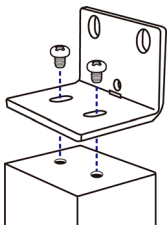

2. Choose either of the following ways to fasten the PDU to the rack.
 - Attach the rack screws to the two rackmount holes of each L-bracket.
 - Screw a mounting button in the back center of each L-bracket and then have both buttons engage the

mounting holes in the rack. The recommended torque for the button is 1.96 N·m (20 kgf·cm).

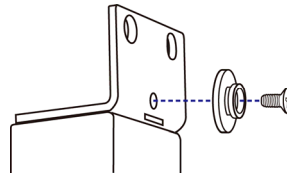

Installing Cable Retention Clips on the Inlet (Optional)

If your PX device is designed to use a cable retention clip, install the clip before connecting a power cord. A cable retention clip prevents the connected power cord from coming loose or falling off.

► To install and use a cable retention clip on the inlet:

1. Install the cable retention clip by inserting two ends of the clip into the two tiny holes adjacent to the inlet.

Zero U models

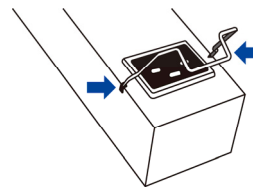

1U/2U models

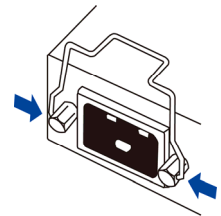

2. Connect the power cord to the inlet, and press the clip to hold the cord.

Zero U models

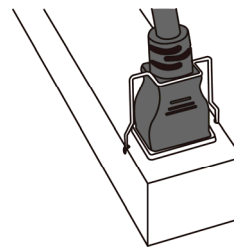

1U/2U models

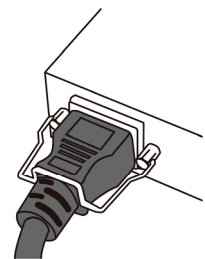

Connecting the PX3 Locking Line Cord

A PX3 phase II model is shipped with a locking line cord. Plug that cord into the PDU's inlet and the cord is securely locked.

Note: To remove the cord, press the locking clips or push the slide buttons at two sides of the cord's connector. For details, see the topic titled "Disconnecting a Locking Line Cord" in the PX3 online help.

Connecting the PX to a Power Source

The distance between a PDU and its power source must be SHORTER than the PDU's line cord to avoid stretching out the cord. A locking connector used at the power source is highly recommended for a secure connection.

► To connect a PDU to the power source:

1. Verify that all circuit breakers on the PX device are set to ON. If not, turn them ON.

Or make sure that all fuses are inserted and seated properly. If there are any fuse covers, ensure that they are closed.

Note: Not all PX devices have overcurrent protection mechanisms.

2. Connect each PX to an appropriately rated branch circuit. See the label or nameplate affixed to your PX for appropriate input ratings or range of ratings.
3. When a PX device powers up, it proceeds with the power-on self test and software loading for a few moments. At this time, the outlet LEDs cycle through different colors.

Note: If a PDU beeps after being powered up, either its circuit breaker has tripped or the L-N wiring is reversed. If no circuit breakers tripped, check the wiring of the plug adapter that is used or the direction in which the plug or plug adapter is plugged into the power socket.

4. When the software has completed loading, the outlet LEDs show a steady color and the front panel display illuminates.

Note: A PX2-1000 or PX3-1000 PDU does not have outlet LEDs so only the front panel display illuminates.

Connecting the PX to Your Network

The PX can be connected to a wired or wireless network.

► To make a wired connection:

1. Connect a standard network patch cable to the ETHERNET port on the PX.
2. Connect the other end of the cable to your LAN.

► To make a wireless connection:

1. Connect an appropriate USB wireless LAN adapter to the PX.
2. Make sure the wireless LAN configuration is supported by the PX.

See **Appendix B: Wireless LAN Information** (on page 8) for details.

Initial Network Configuration

Depending on your networking environment, the best method to initially configure your PX differs.

- For a DHCP IPv4 networking environment, see **Using a Web Browser** (on page 4).
 - For an IPv6 or "static" IPv4 networking environment, see **Appendix A: Configuration via a Connected Computer** (on page 5).
-

Using a Web Browser

Initial configuration using a web browser involves these two steps.

Step 1: Retrieve the IP Address (on page 4)

Step 2: Log in to the PX Web Interface (on page 5)

Step 1: Retrieve the IP Address

After connecting to a DHCP IPv4 network, an IPv4 address is automatically assigned to your PX.

For a PX3 model, the IP address is available using the front panel display.

For a PX2 model, the IP address is available via the command line interface (CLI).





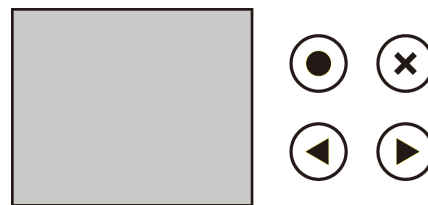

Note: This Quick Setup Guide introduces PX3 "phase II" models only. For information on old PX3 "phase I" models, refer to the PX3 User Guide or online help on the **Support page** (<http://www.raritan.com/support>).

PX3 Phase II Models

A PX3 **phase II** model's front panel display is similar to the following diagram.



► To retrieve the IP address:

1. Press  or  to show the "Main Menu."
2. Press  or  to select "Device Info" in the Main Menu, and press .
3. Press  or  to go to the "IPv4 Settings" page. The second line is the IP address.

PX2 Models

1. Connect the PX2 to a computer via an RS-232 or USB cable. See **Step 1: Connect the PX to a Computer** (on page 5).
2. On the computer, open a communications program with appropriate COM port settings. See **Step 2: Configure the PX via CLI (Optional)** (on page 6) for COM port settings.
3. Press Enter in the communications program, and the IP address is displayed onscreen as illustrated below.

```

Login for PX2 CLI (192.168.84.30)
Enter 'unlock' to unblock a user.
Username: █
    
```

Note: The DHCP-assigned IP address can be also retrieved through the MAC address. You can contact your LAN administrator for assistance. See **MAC Address** (on page 9).

Step 2: Log in to the PX Web Interface

The PX supports common web browsers, including Microsoft Internet Explorer® and Mozilla Firefox®.

► To access the PX web interface:

1. Open a web browser and type the IP address of the PX device.
 - If the link-local addressing has been enabled, you can type *pdu.local* instead of an IP address. See **Appendix A: Configuration via a Connected Computer** (on page 5).



2. Accept any security warnings that may appear.
3. Type the default user name "admin" and password "raritan." Then click Login.

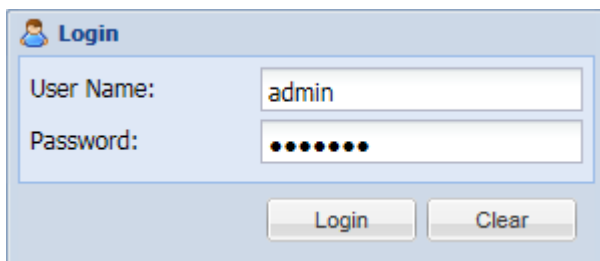

4. When prompted to change the password, change or ignore it.

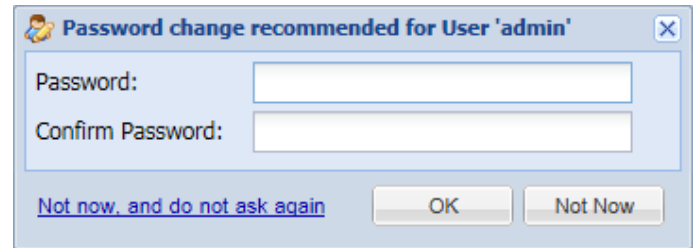

- To change it, type the new password and click OK.
- To ignore it for this time only, click Not Now.
- To ignore it permanently, click "Not now, and do not ask again."

What To Do Next

1. Connect IT equipment to the outlet(s) on the PX.
2. Launch the web browser if not yet. See **Step 2: Log in to the PX Web Interface** (on page 5).
3. Choose Device Settings > Date/Time to configure the PX with the proper date and time or synchronize it with an NTP server. The PX device's time must be in sync with the LDAP server to use LDAP authentication.

Note: If you are using Sunbird's Power IQ to manage the PX, you must configure Power IQ and the PX to have the same date/time or NTP settings.

4. The PX is sent from the factory with all the outlets ON. If your model is outlet-switching capable, turn OFF the outlets without devices connected from the web interface.
5. Use the menu at the top to configure user profiles, privileges, security, outlet thresholds, or network settings.

Note: Detailed instructions are available in the **Online Help or User Guide**.

Appendix A: Configuration via a Connected Computer

To use the command line interface (CLI) for configuration, establish an RS-232 or USB connection.

To use a web browser for configuration, make a network connection to the computer. The PX is automatically configured with the following link-local addressing in any network without DHCP available:

- *https://169.254.x.x* (where x is a number)
- *https://pdu.local*

Step 1: Connect the PX to a Computer

Establish one of the following connections to a computer.

► **Serial RS-232 connection:**

1. Connect one end of the null-modem cable to the male RS-232 port labeled CONSOLE / MODEM on the PX.
2. Connect the other end to your computer's RS-232 port (COM).
3. Perform **Step 2: Configure the PX via CLI (Optional)** (on page 6).

► **USB connection:**

1. A USB-to-serial driver is required in Windows®. Install this driver before connecting the USB cable. See **Installing the USB-to-Serial Driver (Optional)** (on page 9).
2. Connect a USB cable between the PX device's USB-B port and a computer's USB-A port.
3. Perform **Step 2: Configure the PX via CLI (Optional)** (on page 6).

► **Direct network connection:**

1. Connect one end of a standard network patch cable to the ETHERNET port of the PX.
2. Connect the other end to a computer's Ethernet port.
3. On the connected computer, launch a web browser to access the PX, using either link-local addressing: *pdu.local* or *169.254.x.x*. See **Using a Web Browser** (on page 4). You CANNOT use the CLI for this connection.

Note: Make sure the computer's wireless interface is disabled.

Step 2: Configure the PX via CLI (Optional)

You perform the following over an **RS-232** or **USB** connection only.

► **To configure the PX via CLI:**

1. On the computer connected to the PX, open a communications program such as HyperTerminal or PuTTY.
2. Select the appropriate COM port, and set the following port settings:
 - Bits per second = 115200 (115.2Kbps)
 - Data bits = 8
 - Stop bits = 1
 - Parity = None
 - Flow control = None

Tip: For a USB connection, you can determine the COM port by choosing Control Panel > System > Hardware > Device Manager, and locating the "Dominion PX2 Serial Console" under the Ports group.

3. In the communications program, press Enter to send a carriage return to the PX.
4. The PX prompts you to log in. Both user name and password are case sensitive.

- a. Username: `admin`
 - b. Password: `raritan` (or a new password if you have changed it).
5. If prompted to change the default password, change or ignore it.
 - To change it, follow onscreen instructions to type your new password.
 - To ignore it, simply press Enter.
 6. The # prompt appears.
 7. Type `config` and press Enter.
 8. To configure network settings, type appropriate commands and press Enter. All commands are case sensitive.
 - a. To set the networking mode, type this command:

```
network mode <mode>
```

 where `<mode>` is *wired* (default) or *wireless*.
 - b. For the wired network mode, you may configure the LAN interface settings. In most scenarios, the default setting (auto) works well and should not be changed unless required.

To set	Use this command
LAN interface speed	<code>network interface LANInterfaceSpeed <option></code> <code><option></code> = <i>auto</i> , <i>10Mbps</i> , or <i>100Mbps</i> .
LAN interface duplex mode	<code>network interface LANInterfaceDuplexMode <mode></code> <code><mode></code> = <i>half</i> , <i>full</i> or <i>auto</i> .

Tip: You can combine multiple commands to configure multiple parameters at a time. For example,
`network interface LANInterfaceSpeed <option>`
`LANInterfaceDuplexMode <mode>`

- c. For the wireless network mode, you must configure the Service Set Identifier (SSID) parameter.

To set	Use this command
SSID	<code>network wireless SSID <ssid></code> <code><ssid></code> = SSID string

If necessary, configure more wireless parameters shown in the following table.

To set	Use this command
BSSID	network wireless BSSID <bssid> <bssid> = AP MAC address or <i>none</i>
Authentication method	network wireless authMethod <method> <method> = <i>psk</i> or <i>eap</i>
PSK	network wireless PSK <psk> <psk> = PSK string
EAP outer authentication	network wireless eapOuterAuthentication <outer_auth> <outer_auth> = <i>PEAP</i>
EAP inner authentication	network wireless eapInnerAuthentication <inner_auth> <inner_auth> = <i>MSCHAPv2</i>
EAP identity	network wireless eapIdentity <identity> <identity> = your user name for EAP authentication
EAP password	network wireless eapPassword When prompted to enter the password for EAP authentication, type the password.
EAP CA certificate	network wireless eapCACertificate When prompted to enter the CA certificate, open the certificate with a text editor, copy and paste the content into the communications program.

The content to be copied from the CA certificate does NOT include the first line containing "BEGIN CERTIFICATE" and the final line containing "END CERTIFICATE." If a certificate is installed, configure the following:

Whether to	Use this command
Verify the certificate	network wireless enableCertVerification <option1> <option1> = <i>true</i> or <i>false</i>
Accept an expired or not valid certificate	network wireless allowOffTimeRangeCerts <option2> <option2> = <i>true</i> or <i>false</i>

Whether to	Use this command
Make the connection successful by ignoring the "incorrect" system time	network wireless allowConnectionWithIncorrectClock <option3> <option3> = <i>true</i> or <i>false</i>

- d. To determine which IP protocol (IPv4 or IPv6) is enabled and which IP address (IPv4 or IPv6) returned by the DNS server is used, configure the following parameters.

To set	Use this command
IP protocol	network ip proto <protocol> <protocol> = <i>v4Only</i> , <i>v6Only</i> or <i>both</i>
IP address returned by the DNS server	network ip dnsResolverPreference <resolver> <resolver> = <i>preferV4</i> or <i>preferV6</i>

- e. After enabling the IPv4 or IPv6 protocol in the earlier step, configure the IPv4 or IPv6 network parameters.

To set	Use this command
IPv4 configuration method	network ipv4 ipConfigurationMode <mode> <mode> = <i>dhcp</i> (default) or <i>static</i>
IPv6 configuration method	network ipv6 ipConfigurationMode <mode> <mode> = <i>automatic</i> (default) or <i>static</i>

- Configure the preferred host name for the IPv4 DHCP or IPv6 automatic configuration.

Note: The <version> variable in all of the following commands is either *ipv4* or *ipv6*, depending on the type of the IP protocol you have enabled.

To set	Use this command
Preferred host name (optional)	network <version> preferredHostName <name> <name> = preferred host name

Tip: To override the DHCP-assigned DNS servers with those you specify manually, type this command:

```
network <version> overrideDNS <option>
```

where <option> is `enable` or `disable`. See the table below for the commands for manually specifying DNS servers.

- For static IP configuration, configure these parameters.

To set	Use this command
Static IPv4 or IPv6 address	<code>network <version> ipAddress <ip address></code> <ip address> = static IP address
IPv4 subnet mask	<code>network ipv4 subnetMask <netmask></code> <netmask> = subnet mask
IPv4 or IPv6 gateway	<code>network <version> gateway <ip address></code> <ip address> = gateway's IP address
IPv4 or IPv6 primary DNS server	<code>network <version> primaryDNSServer <ip address></code> <ip address> = IP address of the primary DNS server
IPv4 or IPv6 secondary DNS server (optional)	<code>network <version> secondaryDNSServer <ip address></code> <ip address> = IP address of the secondary DNS server

9. To quit the configuration mode, type either of the following commands, and press Enter.

Command	Description
<code>apply</code>	Save all configuration changes and exit.
<code>cancel</code>	Abort all configuration changes and exit.

The # prompt appears, indicating that you have quit the configuration mode.

10. To verify whether all settings are correct, type the following commands one by one.

Command	Description
<code>show network</code>	Show network parameters.
<code>show network ip all</code>	Show all IP configuration parameters.

Command	Description
<code>show network wireless details</code>	Show all wireless parameters.

Tip: You can type "show network wireless" to display a shortened version of wireless settings.

11. If all are correct, type `exit` to log out of the PX. If any are incorrect, repeat Steps 7 to 10 to change network settings.

Appendix B: Wireless LAN Information

USB Wireless LAN Adapters

The PX supports the following USB Wi-Fi LAN adapters.

Wi-Fi LAN adapters	Supported 802.11 protocols
Proxim Orinoco 8494	A/B/G
Zyxel NWD271N	B/G
Edimax EW-7722UnD	A/B/G/N
TP-Link TL-WDN3200 v1	A/B/G/N
Raritan USB WIFI	A/B/G/N

Note: To use the Edimax EW-7722UnD or Raritan USB WIFI wireless LAN adapter to connect to an 802.11n wireless network, the handshake timeout setting must be changed to 500 or greater, or the wireless connection will fail.

Connecting the Wireless LAN Adapter

You can connect the wireless LAN adapter either to the PX or to a USB docking station attached to the PX.

► To make a wireless connection:

Do one of the following:

- Plug a supported USB wireless LAN adapter into the USB-A port on your PX.
- Connect a USB docking station to the USB-A port on the PX. Then plug the supported USB wireless LAN adapter into the appropriate USB port on the docking station.

Supported Wireless LAN Configuration

If wireless networking is preferred, ensure that the wireless LAN configuration of your PX matches the access point. The following is the wireless LAN configuration that the PX supports.

- Network type: 802.11 A/B/G/N
- Protocol: WPA2 (RSN)

- Key management: WPA-PSK, or WPA-EAP with PEAP and MSCHAPv2 authentication
- Encryption: CCMP (AES)

Important: Supported 802.11 network protocols vary according to the wireless LAN adapter being used with the PX. See *USB Wireless LAN Adapters* (on page 8).

Appendix C: Other Information

Installing the USB-to-Serial Driver (Optional)

The PX can emulate a USB-to-serial converter over a USB connection. A USB-to-serial driver named "Dominion PX2 Serial Console" is required for Microsoft® Windows® operating systems.

Download the USB serial console driver from the Raritan website's **Support page** (<http://www.raritan.com/support/>). The driver contains the *dominion-serial.inf*, *dominion-serial.cat* and *dominion-serial-setup-<n>.exe* files.

Note: <n> in the filename of "dominion-serial-setup-<n>.exe" represents the file's version number.

There are two ways to install this driver: automatic and manual installation. Automatic driver installation is highly recommended.

► Automatic driver installation in Windows®:

1. Make sure the PX is NOT connected to the computer via a USB cable.
2. Run *dominion-serial-setup-<n>.exe* on the computer and follow online instructions to install the driver.

Note: If any Windows security warning appears, accept it to continue the installation.

3. Connect the PX to the computer via a USB cable. The driver is automatically installed.

Note: Manually install the driver only if the automatic installation fails. See the section titled "Installing the USB-to-Serial Driver (Optional)" in the online help for manual installation procedure.

► In Linux:

No additional drivers are required, but you must provide the name of the tty device, which can be found in the output of the "dmesg" after connecting the PX to the computer. Usually the tty device is "/dev/ttyACM#" or "/dev/ttyUSB#", where # is an integer number.

For example, if you are using the kermit terminal program, and the tty device is "/dev/ttyACM0," perform the following commands:

```
> set line /dev/ttyACM0
```

```
> connect
```

MAC Address

A label is affixed to the PX, showing both the serial number and MAC address.



If necessary, you can find its IP address through the MAC address by using commonly-used network tools. Contact your LAN administrator for assistance.

PX3 Replaceable Controller

The controller of a PX3 model is replaceable if it is broken. Contact Raritan when a replacement controller is needed.

For detailed information on how to remove it, see the topic titled "Replaceable Controller" in the PX3 online help.

