

## Raritan PX2, PX3 and PX3-iX7

Thank you for purchasing the Raritan intelligent power distribution unit (PDU) -- PX2, PX3, or PX3 with iX7™ controller (also known as PX3-iX7 or iX7™). The intended use of the Raritan PX2/PX3 is distribution of power to information technology equipment such as computers and communication equipment where such equipment is typically mounted in an equipment rack located in an information technology equipment room.

This Quick Setup Guide explains how to install and configure the PX2/PX3. For further details on using the PX2/PX3, access online help from the application, or download the user guide from the Raritan website's **Support page** (<http://www.raritan.com/support/>). For more detailed information on this release, see the latest release notes on the Support page.

**Note: In this guide, PX3 refers to both PX3 and PX3-iX7 models unless otherwise specified. For major differences between the two product models, see *iX7-Specific Features* (on page 9).**

### Safety Precautions

**WARNING!** Read and understand all sections in this guide before installing or operating this product. Failure to heed any of the following WARNINGS may result in electric shock, fire, personal injury and death. Prior to operating this product, the user should read the online help and specifically the warnings in the online help.

**WARNING!** Connect this product to an AC power source whose voltage is within the range specified on the product's nameplate.

**WARNING!** Connect this product to an AC power source that is current limited by a suitably rated fuse or circuit breaker in accordance with national and local electrical codes.

**WARNING!** Use this product in a dry location.

**WARNING!** Connect this product to a protective earth ground. Never use a "ground lift adaptor" between the product's plug and the wall receptacle.

**WARNING!** If this product is a model that requires assembly of its line cord or plug, all such assembly must be performed by a licensed electrician and the line cord or plugs used must be suitably rated based on the product's nameplate ratings and national and local electrical codes.

### Unpacking the PX2/PX3

The PX2/PX3 comes in Zero U, 1U, and 2U sizes. The following describes the equipment shipped with each size. Unpack the components. If any pieces are missing or damaged, report

this to Raritan Technical Support at [tech@raritan.com](mailto:tech@raritan.com), or contact the Raritan partner where you purchased the product.

#### Zero U Size

- PX2 or PX3 PDU
- Mounting screws, brackets and/or buttons
- Cable retention clips for the inlet and/or outlets (for some models only)
- An "optional" null-modem cable with DB9 connectors on both ends (Raritan number: 254-01-0006-00)

Note: For **PX3-iX7**, use a third party RJ45-to-DB9 adapter/cable instead of the null-modem cable.

#### 1U and 2U Size

- PX2 or PX3 PDU
- 1U or 2U bracket pack and screws
- Cable retention clips for the inlet (for some models only)
- An "optional" null-modem cable with DB9 connectors on both ends (Raritan number: 254-01-0006-00)

Note: For **PX3-iX7**, use a third party RJ45-to-DB9 adapter/cable instead of the null-modem cable.

### Before You Begin

1. Prepare the installation site. Make sure the installation area is clean and not exposed to extreme temperatures or

humidity. Allow sufficient space around the device for cabling and outlet connections. Safety instructions are provided in the PX2/PX3 Online Help.

2. Fill out the Equipment Setup Worksheet found in the PX2/PX3 Online Help. Record the model, serial number, and use of each IT device connected to the PDU's power outlets.

## Mounting the PDU

Use one of the mounting methods to install your PX2/PX3 as appropriate.

### Circuit Breaker Orientation Limitation

Usually a PDU can be mounted in any orientation. However, when mounting a PDU with circuit breakers, you must obey these rules:

- Circuit breakers CANNOT face down. For example, do not horizontally mount a Zero U PDU with circuit breakers on the ceiling.
- If a rack is subject to shock in environments such as boats or airplanes, the PDU CANNOT be mounted upside down. If installed upside down, shock stress reduces the trip point by 10%.

Note: If normally the line cord is down, upside down means the line cord is up.

## Mounting 1U or 2U Models

Using the appropriate brackets and tools, fasten the 1U or 2U device to the rack or cabinet.

### ► To mount the PX2/PX3 device:

1. Attach a rackmount bracket to both sides of the PX2/PX3 with the provided screws.

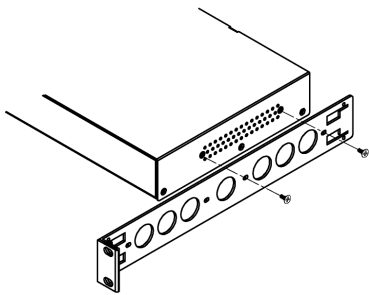

2. Insert the cable-support bar into rackmount brackets.

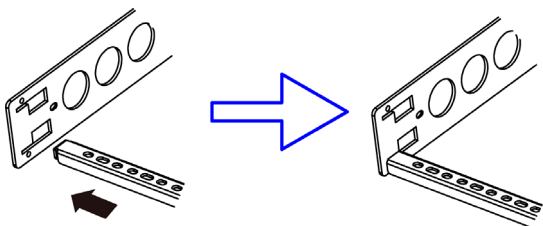

3. Secure with the provided end cap screws.

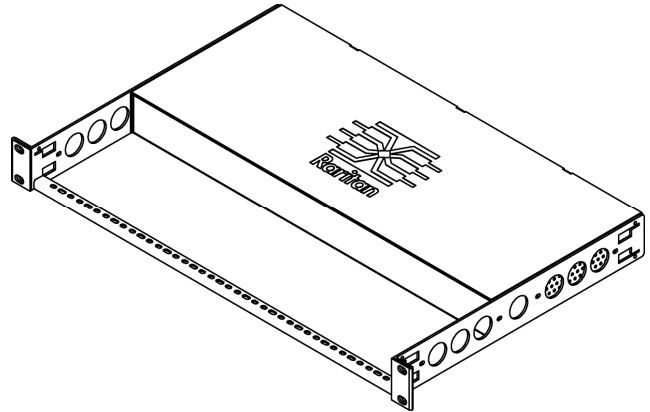
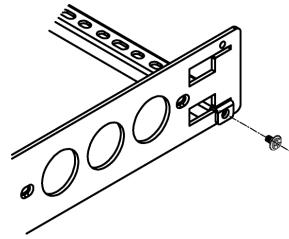

4. Fasten the rackmount brackets' ears to the rack using your own fasteners.

## Mounting Zero U Models Using Baseplate-Based Tools

You can use one of the three baseplate-based tools to mount the PDU: L-brackets, buttons or claw-foot brackets.

### ► To mount Zero U models using baseplates:

1. Align the baseplates on the rear of the PX2/PX3 device.
2. Make the baseplates grasp the device lightly. Use the included L-shaped hex key to loosen the hex socket screws until the baseplate is "slightly" fastened.

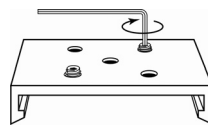

3. Attach brackets or buttons to the baseplates.

- Fasten each L-bracket or claw-foot bracket to each baseplate with at least three screws (one through each slot).

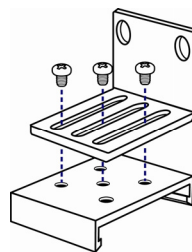

OR

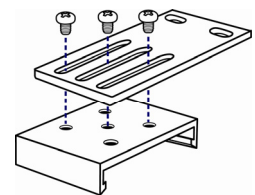

- Screw each mounting button to each baseplate. The recommended torque for the button is 1.96 N·m (20 kgf·cm).

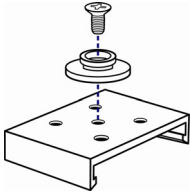

4. Fasten the device to the rack or cabinet using the baseplate-based tools.
  - Use rack screws to fasten L-brackets or claw-foot brackets on the PDU to the rack.
  - For the buttons, press the PDU forward, pushing the mounting buttons through the mounting holes, then letting the device drop about 5/8".

## Mounting Zero U Models Using Buttons

1. Turn to the rear of the PDU.
2. Locate the two screw holes on the rear panel.
3. Screw a button in each screw hole. The recommended torque for the button is 1.96 N·m (20 kgf·cm).

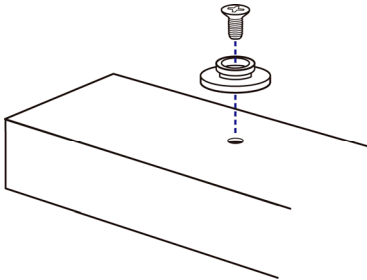

4. Press the PDU forward, pushing the mounting buttons through the mounting holes, then letting the PDU drop slightly.

## Mounting Zero U Models Using L-Brackets and Buttons

1. Fasten the L-bracket to each end of the PDU.

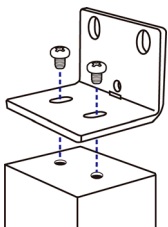

2. Choose either of the following ways to fasten the PDU to the rack.
  - Attach the rack screws to the two rackmount holes of each L-bracket.
  - Screw a mounting button in the back center of each L-bracket and then have both buttons engage the

mounting holes in the rack. The recommended torque for the button is 1.96 N·m (20 kgf·cm).

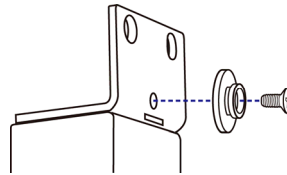

## Installing Cable Retention Clips on the Inlet (Optional)

If your PX2/PX3 device is designed to use a cable retention clip, install the clip before connecting a power cord. A cable retention clip prevents the connected power cord from coming loose or falling off.

### ► To install and use a cable retention clip on the inlet:

1. Install the cable retention clip by inserting two ends of the clip into the two tiny holes adjacent to the inlet.

#### Zero U models

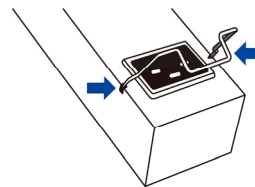

#### 1U/2U models

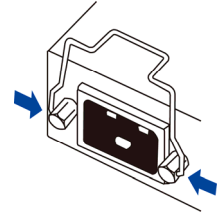

2. Connect the power cord to the inlet, and press the clip to hold the cord.

#### Zero U models

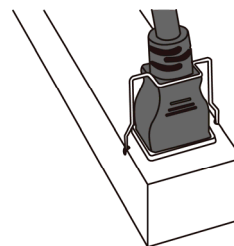

#### 1U/2U models

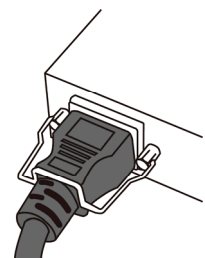

## Connecting the PX3 Locking Line Cord

A PX3 model is shipped with a locking line cord. Plug that cord into the PDU's inlet and the cord is securely locked.

Note: To remove the cord, press the locking clips or push the slide buttons at two sides of the cord's connector. For details, see the topic titled "Disconnecting a Locking Line Cord" in the PX3 online help.

## Connecting the PDU to a Power Source

The distance between a PDU and its power source must be SHORTER than the PDU's line cord to avoid stretching out the cord. A locking connector used at the power source is highly recommended for a secure connection.

### ▶ To connect a PDU to the power source:

1. Verify that all circuit breakers on the PX2/PX3 device are set to ON. If not, turn them ON.

Or make sure that all fuses are inserted and seated properly. If there are any fuse covers, ensure that they are closed.

---

Note: Not all PX2/PX3 devices have overcurrent protection mechanisms.

---

2. Connect each PX2/PX3 to an appropriately rated branch circuit. See the label or nameplate affixed to your PX2/PX3 for appropriate input ratings or range of ratings.
3. When a PX2/PX3 device powers up, it proceeds with the power-on self test and software loading for a few moments. At this time, the outlet LEDs cycle through different colors.

---

Note: If a PDU beeps after being powered up, either its circuit breaker has tripped or the L-N wiring is reversed. If no circuit breakers tripped, check the wiring of the plug adapter that is used or the direction in which the plug or plug adapter is plugged into the power socket.

---

4. When the software has completed loading, the outlet LEDs show a steady color and the front panel display illuminates.

---

Note: A PX2-1000 or PX3-1000 PDU does not have outlet LEDs so only the front panel display illuminates.

---

## Connecting the PDU to Your Network

PX2/PX3 can be connected to a wired or wireless network.

### ▶ To make a wired connection:

1. Connect a standard network patch cable to the ETHERNET port on the PX2/PX3.
2. Connect the other end of the cable to your LAN.

---

Note: For **PX3-iX7**, you can connect either Ethernet port to the LAN, but the "green" port labeled "ETH⑩10/100/1000" is highly recommended because it supports 1000 Mbps. If connecting both ports to the LAN, you must connect them to two "different" subnets. If you are not sure whether the PDU is connected to the same or different subnets, contact your IT department.

---

### ▶ To make a wireless connection:

1. Connect an appropriate USB wireless LAN adapter to the PDU.

2. Make sure the wireless LAN configuration is supported by your PDU. See **Appendix B: Wireless LAN Information** (on page 8).

## Initial Network Configuration

Depending on your networking environment, the best method to initially configure your PX2/PX3 differs.

- For a DHCP IPv4 networking environment, see **Using a Web Browser** (on page 4).
- For an IPv6 or "static" IPv4 networking environment, see **Appendix A: Configuration via a Connected Computer** (on page 5).

## Using a Web Browser

Initial configuration using a web browser involves these two steps.

**Step 1: Retrieve the IP Address** (on page 4)

**Step 2: Log in to the PX2/PX3 Web Interface** (on page 5)

### Step 1: Retrieve the IP Address

After connecting to a DHCP IPv4 network, an IPv4 address is automatically assigned to your PX2/PX3.

A PX3 model's IP address is available using the front panel display.















A PX2 model's IP address is available via the command line interface (CLI).

### PX3 Models

Depending on the PX3 model you purchased, the front panel display is similar to either diagram below.



### ▶ To retrieve the IP address:

1. Press   or   to show the "Main Menu."
2. Press   or   to select "Device Info," and press  .
3. Press   or   until the device's IP address is displayed.

### PX2 Models

1. Connect PX2 to a computer via an RS-232 or USB cable. See **Step 1: Connect the PX2/PX3 to a Computer** (on page 5).

2. On the computer, open a communications program with appropriate COM port settings. See **Step 2: Configure the PX2/PX3 via CLI (Optional)** (on page 6) for COM port settings.
3. Press Enter in the communications program, and the IP address is displayed onscreen as illustrated below.

```
Login for PX2 CLI (192.168.84.30)
Enter 'unlock' to unblock a user.
Username: █
```

Note: The DHCP-assigned IP address can be also retrieved through the MAC address. You can contact your LAN administrator for assistance. See **MAC Address** (on page 9).

## Step 2: Log in to the PX2/PX3 Web Interface

The PX2/PX3 supports common web browsers, including Microsoft Internet Explorer®, Mozilla Firefox®, and Google® Chrome.

### ► To access the PX2/PX3 web interface:

1. Open a web browser and type the IP address of the PX2/PX3 device.
  - If the link-local addressing has been enabled, you can type *pdu.local* instead of an IP address. See **Appendix A: Configuration via a Connected Computer** (on page 5).

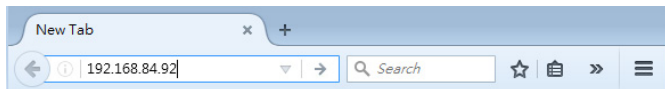

2. Accept any security warnings that may appear.
3. Type the default user credentials and click Login.
  - User name: admin
  - Password: raritan
4. When prompted to change the password, change or ignore it.
  - To change it, type the new password and click Ok.
  - To ignore it for this time only, click Not Now.
  - To ignore it permanently, select "Do not ask again" and click Not Now.

## What To Do Next

1. Connect IT equipment to the outlet(s) on the PX2/PX3.
2. Launch the web browser if not yet. See **Step 2: Log in to the PX2/PX3 Web Interface** (on page 5).
3. Choose Device Settings > Date/Time to configure the PX2/PX3 with the proper date and time or synchronize it with an NTP server. The PX2/PX3 device's time must be in sync with the LDAP server to use LDAP authentication.

---

Note: If you are using Sunbird's Power IQ to manage the PX2/PX3, you must configure Power IQ and the PX2/PX3 to have the same date/time or NTP settings.

---

4. To change network settings, choose Device Settings > Network.

---

Tip: As of release 3.3.10, you can enable both wired and wireless networking so that the PX2/PX3 can be accessed via both wired and wireless IP addresses.

---

5. The PX2/PX3 is sent from the factory with all the outlets ON. If your model is outlet-switching capable, turn OFF the outlets without devices connected.
6. Use the menu to the left to configure user profiles, privileges, security, outlet thresholds, or network settings.

---

Note: Detailed instructions are available in the PX2 or PX3 Online Help or User Guide.

---

## Appendix A: Configuration via a Connected Computer

To use the command line interface (CLI) for configuration, establish an RS-232 or USB connection.

To use a web browser for configuration, make a network connection to the computer. The PX2/PX3 is automatically configured with the following link-local addressing in any network without DHCP available:

- `https://169.254.x.x` (where x is a number)
- `https://pdu.local`

## Step 1: Connect the PX2/PX3 to a Computer

Establish one of the following connections to a computer.

### ► Serial connection for "DB9" RS-232 connector on PX2/PX3:

1. Connect one end of the null-modem DB9 cable to the male "DB9" RS-232 port labeled CONSOLE / MODEM on the PX2/PX3.
2. Connect the other end to your computer's RS-232 port (COM).
3. Perform **Step 2: Configure the PX2/PX3 via CLI (Optional)** (on page 6).

### ► Serial connection for "RJ-45" RS-232 connector on PX3-iX7:

The iX7™ PDU's serial connection procedure is the same as above except that a third party RJ-45 to "DB9 female" adapter/cable is required, such as the blue Cisco adapter cable. This is because the CONSOLE / MODEM port on iX7™ is a female RJ-45 connector.

► **USB connection:**

1. A USB-to-serial driver is required in Windows®. Install this driver before connecting the USB cable. See *Installing the USB-to-Serial Driver (Optional)* (on page 8).
2. Connect a USB cable between the PX2/PX3 device's USB-B port and a computer's USB-A port.
3. Perform **Step 2: Configure the PX2/PX3 via CLI (Optional)** (on page 6).

► **Direct network connection:**

The Ethernet port must be enabled for this connection to work properly. Per default, the Ethernet port is enabled.

1. Connect one end of a standard network patch cable to the ETHERNET port of the PX2/PX3.
  - For iX7™, either Ethernet port is fine.
2. Connect the other end to a computer's Ethernet port.
3. On the connected computer, launch a web browser to access the PX2/PX3, using either link-local addressing: *pdu.local* or *169.254.x.x*. See *Using a Web Browser* (on page 4). You CANNOT use the CLI for this connection.

---

Note: Make sure the computer's wireless interface is disabled.

---

## Step 2: Configure the PX2/PX3 via CLI (Optional)

You perform the following over an **RS-232** or **USB** connection only.

► **To configure the PX2/PX3 via CLI:**

1. On the computer connected to the PX2/PX3, open a communications program such as HyperTerminal or PuTTY.
2. Select the appropriate COM port, and set the following port settings:
  - Bits per second = 115200 (115.2Kbps)
  - Data bits = 8
  - Stop bits = 1
  - Parity = None
  - Flow control = None

---

Tip: For a USB connection, you can determine the COM port by choosing Control Panel > System > Hardware > Device Manager, and locating the "Dominion PX2 Serial Console" under the Ports group.

---
3. In the communications program, press Enter to send a carriage return to the PX2/PX3.
4. The PX2/PX3 prompts you to log in. Both user name and password are case sensitive.
  - a. Username: `admin`
  - b. Password: `raritan` (or a new password if you have changed it).

5. If prompted to change the default password, change or ignore it.
  - To change it, follow onscreen instructions to type your new password.
  - To ignore it, simply press Enter.
6. The # prompt appears.
7. Type `config` and press Enter.
8. To configure network settings, type appropriate commands and press Enter. Refer to the following commands list. CLI commands are case sensitive.
9. After finishing the network settings, type `apply` to save changes. To abort, type `cancel`.

► **Commands for wired networking:**

The `<ipvX>` variable in the following commands is either *ipv4* or *ipv6*, depending on the type of IP protocol you are configuring.

For PX2 and PX3, replace the variable `<ETH>` with the word "ethernet". For PX3-iX7, replace the variable `<ETH>` with either 'ETH1' or 'ETH2', depending on which Ethernet port you are configuring.

• **General IP settings:**

To set or enable	Use this command
IPv4 or IPv6 protocol	<code>network &lt;ipvX&gt; interface &lt;ETH&gt; enabled &lt;option&gt;</code>  <code>&lt;option&gt; = true, or false</code>
IPv4 configuration method	<code>network ipv4 interface &lt;ETH&gt; configMethod &lt;mode&gt;</code>  <code>&lt;mode&gt; = dhcp (default) or static</code>
IPv6 configuration method	<code>network ipv6 interface &lt;ETH&gt; configMethod &lt;mode&gt;</code>  <code>&lt;mode&gt; = automatic (default) or static</code>
Preferred host name (optional)	<code>network &lt;ipvX&gt; interface &lt;ETH&gt; preferredHostName &lt;name&gt;</code>  <code>&lt;name&gt; = preferred host name</code>
IP address returned by the DNS server	<code>network dns resolverPreference &lt;resolver&gt;</code>  <code>&lt;resolver&gt; = preferV4 or preferV6</code>

• **Static IP configuration:**

To set	Use this command
Static IPv4 or IPv6 address	<pre>network &lt;ipvX&gt; interface &lt;ETH&gt; address &lt;ip address&gt;</pre> <p>&lt;ip address&gt; = static IP address, with a syntax similar to the example below. Example: <i>192.168.7.9/24</i></p>
Static IPv4 or IPv6 gateway	<pre>network &lt;ipvX&gt; gateway &lt;ip address&gt;</pre> <p>&lt;ip address&gt; = gateway's IP address</p>
IPv4 or IPv6 primary DNS server	<pre>network dns firstServer &lt;ip address&gt;</pre> <p>&lt;ip address&gt; = DNS server's IP address</p>
IPv4 or IPv6 secondary DNS server	<pre>network dns secondServer &lt;ip address&gt;</pre> <p>&lt;ip address&gt; = DNS server's IP address</p>
IPv4 or IPv6 third DNS server	<pre>network dns thirdServer &lt;ip address&gt;</pre> <p>&lt;ip address&gt; = DNS server's IP address</p>

- ▶ **Commands for wireless networking:**
- **General wireless settings:**

To set or enable	Use this command
Wireless interface	<pre>network wireless enabled &lt;option&gt;</pre> <p>&lt;option&gt; = <i>true</i>, or <i>false</i></p>
SSID	<pre>network wireless SSID &lt;ssid&gt;</pre> <p>&lt;ssid&gt; = SSID string</p>
BSSID	<pre>network wireless BSSID &lt;bssid&gt;</pre> <p>&lt;bssid&gt; = AP MAC address or <i>none</i></p>
802.11n protocol	<pre>network wireless enableHT &lt;option&gt;</pre> <p>&lt;option&gt; = <i>true</i>, or <i>false</i></p>
Authentication method	<pre>network wireless authMethod &lt;method&gt;</pre> <p>&lt;method&gt; = <i>psk</i> or <i>eap</i></p>
PSK	<pre>network wireless PSK &lt;psk&gt;</pre> <p>&lt;psk&gt; = PSK string</p>
EAP outer authentication	<pre>network wireless eapOuterAuthentication &lt;outer_auth&gt;</pre> <p>&lt;outer_auth&gt; = <i>PEAP</i></p>

To set or enable	Use this command
EAP inner authentication	<pre>network wireless eapInnerAuthentication &lt;inner_auth&gt;</pre> <p>&lt;inner_auth&gt; = <i>MSCHAPv2</i></p>
EAP identity	<pre>network wireless eapIdentity &lt;identity&gt;</pre> <p>&lt;identity&gt; = your user name for EAP authentication</p>
EAP password	<pre>network wireless eapPassword</pre> <p>When prompted to enter the password for EAP authentication, type the password.</p>
EAP CA certificate	<pre>network wireless eapCACertificate</pre> <p>When prompted to enter the CA certificate, open the certificate with a text editor, copy and paste the content into the communications program.</p>

The content to be copied from the CA certificate does NOT include the first line containing "BEGIN CERTIFICATE" and the final line containing "END CERTIFICATE." If a certificate is installed, configure the following:

Whether to	Use this command
Verify the certificate	<pre>network wireless enableCertVerification &lt;option1&gt;</pre> <p>&lt;option1&gt; = <i>true</i> or <i>false</i></p>
Accept an expired or not valid certificate	<pre>network wireless allowOffTimeRangeCerts &lt;option2&gt;</pre> <p>&lt;option2&gt; = <i>true</i> or <i>false</i></p>
Make the connection successful by ignoring the "incorrect" system time	<pre>network wireless allowConnectionWithIncorrectClock &lt;option3&gt;</pre> <p>&lt;option3&gt; = <i>true</i> or <i>false</i></p>

- **Wireless IPv4 / IPv6 settings:**

Commands for wireless IP settings are identical to those for wired networking. Just replace the variable <ETH> with the word 'wireless'. The following illustrates a few examples.

To set or enable	Use this command
IPv4 configuration method	network ipv4 interface WIRELESS configMethod <mode>  <mode> = <i>dhcp</i> (default) or <i>static</i>
IPv6 configuration method	network ipv6 interface WIRELESS configMethod <mode>  <mode> = <i>automatic</i> (default) or <i>static</i>

► **To verify network settings:**

After exiting the above configuration mode and the # prompt re-appears, type this command to verify all network settings.

- show network

## Appendix B: Wireless LAN Information

### USB Wireless LAN Adapters

The PX2/PX3 supports the following USB Wi-Fi LAN adapters.

Wi-Fi LAN adapters	Supported 802.11 protocols
SparkLAN WUBR-508N	A/B/G/N
Proxim Orinoco 8494	A/B/G
Zyxel NWD271N	B/G
Edimax EW-7722UnD	A/B/G/N
TP-Link TL-WDN3200 v1	A/B/G/N
Raritan USB WIFI	A/B/G/N

Note: To use the Edimax EW-7722UnD or Raritan USB WIFI wireless LAN adapter to connect to an 802.11n wireless network, the handshake timeout setting must be changed to 500 or greater, or the wireless connection will fail.

### Connecting the Wireless LAN Adapter

You can connect the wireless LAN adapter either to the PDU or to a USB hub attached to the PDU.

► **To make a wireless connection:**

Do one of the following:

- Plug a supported USB wireless LAN adapter into the USB-A port on your PX2/PX3.
- Connect a USB hub to the USB-A port on the PX2/PX3. Then plug the supported USB wireless LAN adapter into the appropriate USB port on the hub.

## Supported Wireless LAN Configuration

If wireless networking is preferred, ensure that the wireless LAN configuration of your PX2/PX3 matches the access point. The following is the wireless LAN configuration that the PX2/PX3 supports.

- Network type: 802.11 A/B/G/N
- Protocol: WPA2 (RSN)
- Key management: WPA-PSK, or WPA-EAP with PEAP and MSCHAPv2 authentication
- Encryption: CCMP (AES)

---

**Important: Supported 802.11 network protocols vary according to the wireless LAN adapter being used with the PX2/PX3. See *USB Wireless LAN Adapters* (on page 8).**

---

## Appendix C: Other Information

### Installing the USB-to-Serial Driver (Optional)

The PX2/PX3 can emulate a USB-to-serial converter over a USB connection. A USB-to-serial driver named "Dominion PX2 Serial Console" is required for Microsoft® Windows® operating systems.

Download the Windows driver for USB serial console from the Raritan website's **Support page** (<http://www.raritan.com/support/>). The downloaded driver's name is *dominion-serial-setup-<n>.exe*, where <n> represents the file's version number.

There are two ways to install this driver: automatic and manual installation. Automatic driver installation is highly recommended.

► **Automatic driver installation in Windows®:**

1. Make sure the PX2/PX3 is NOT connected to the computer via a USB cable.
2. Run *dominion-serial-setup-<n>.exe* on the computer and follow online instructions to install the driver.

---

Note: If any Windows security warning appears, accept it to continue the installation.

---

3. Connect the PX2/PX3 to the computer via a USB cable. The driver is automatically installed.

---

Note: Manual installation is required only if the automatic installation fails. See the section titled "Installing the USB-to-Serial Driver (Optional)" in the online help for manual installation procedure.

---

► **In Linux:**

No additional drivers are required, but you must provide the name of the tty device, which can be found in the output of the "dmesg" after connecting the PX2/PX3 to the computer.



Usually the tty device is `"/dev/ttyACM#" or "/dev/ttyUSB#," where # is an integer number.`

For example, if you are using the kermit terminal program, and the tty device is `"/dev/ttyACM0,"` perform the following commands:

```
> set line /dev/ttyACM0
> connect
```

## MAC Address

A label is affixed to the PX2/PX3, showing both the serial number and MAC address.



If necessary, you can find its IP address through the MAC address by using commonly-used network tools. Contact your LAN administrator for assistance.

## PX3 Replaceable Controller

The controller of a PX3 model is replaceable if it is broken. Contact Raritan Technical Support when a replacement controller is needed.

For detailed information on how to remove it, see the topic titled "Replaceable Controller" in the PX3 online help.

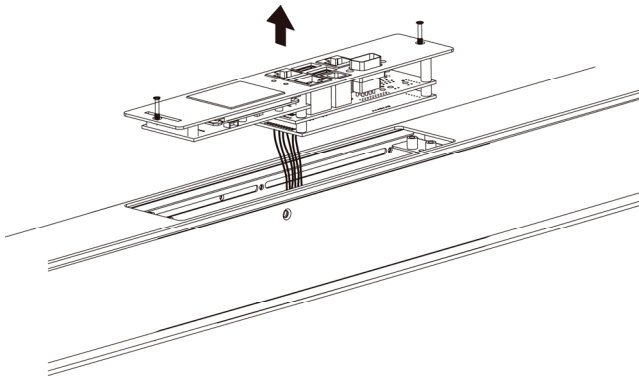

## iX7-Specific Features

PX3 with iX7™ controller supports the following significant features, which are NOT supported by non-iX7 PX3 models.

- Dual networking with two Ethernet ports (ETH1/ETH2): Both Ethernet ports must connect to two "different" subnets. Connection to the same subnet is NOT recommended.
- Power sharing via the EXPANSION port: Power sharing ensures the continuous accessibility to the iX7™ controller when a power failure occurs on its inlet.

For more information on dual Ethernet and power sharing functionality, refer to PX3 online help or user guide. Port

locations on your iX7™ may look different from the following illustration.

