

Technical Specification

Raritan PX
Model Number: PX2-1966

380-415V 3Ø
16A
10.6-11.5KVA



Line Drawing



Features

Energy Metering	Voltage (V), Current (A), Active Power (kW), Real Power (kVA), Energy (kWh), Power Factor
Metering Accuracy	ISO/IEC 62053-21 1%
Metering per Input Line	Yes
Metering per Branch Circuit Breaker	Yes
Metering per Output Receptacle	No
Remote Outlet Switching	No
Environmental Sensor Ready	Yes
Networking	10/100 BaseT Ethernet. Optional WiFi (802.11a/b/g/n)
Remote Management	HTTP(s); SSH; Telnet; RS-232 (Serial); Power IQ; SNMP version v2/v3; SMTP; JSON-RPC
Cascading	Yes up to (4) PDUs in a single cabinet can share a single Ethernet connection
Onboard Display	3-digit user-selectable display (can be selected between Manual and Auto Display Mode). Can display Line voltage, Line current, CB Current (if IPDU supports CBs) and Unit active power, and Unbalanced Current percentage
Compatible Sensors	Temperature, Humidity, Air Flow, Static Pressure Single cable connection provides temp/humidity monitoring at three points in cabinet (with a single sensor assembly)

Input

Input Plug	IEC 60309 3P+N+E 6h 16A 4P5W (L1/L2/L3/N/E) IP44("splashproof") (400V, 3 phase)	
Cord Length	3 meters (9.84 feet) standard	
Cord Entry	Bottom-front feed	
Cable Type	4P 5W	
Number of Power Cords	1	
Maximum Input Current	16A (per line)	
Nominal Input Voltage	400V, 3 phase	
Rated Input Voltage	380 - 415V, 3 phase	
Input Frequency	50/60Hz	
Power Capacity	10.6kVA at 380V, 11.5kVA at 415V	

Output

Nominal Output Voltage	230V
Rated Output Voltage	220 - 240V
Output Connections	a. (36) IEC 60320 C13 2-pole, 3-wire; 10A b. (6) IEC 60320 C19 2-pole, 3-wire; 16A
Overload Protection	N/A
Cable Retention	Raritan SecureLock™ Ready Optional retention clips are also available

Physical

Dimensions (W x D x H)	2.1" x 2.1" x 70.1" ; 52mm x 53mm x 1780mm
Color	Black powder coat
Mounting	RACK-KIT-PX2-1K-ZU

Environmental

Operating Environment	5 - 50°C (41 - 122°F)
Operating Relative Humidity	5-85%
Operating Elevation	0-10000ft

Conformance

Regulatory Approvals	CE Canada ICES-003, Class A Part 15 Class A of the FCC rules RoHS compliant
----------------------	--

Control Panel Detail



Electrical Drawing Detail

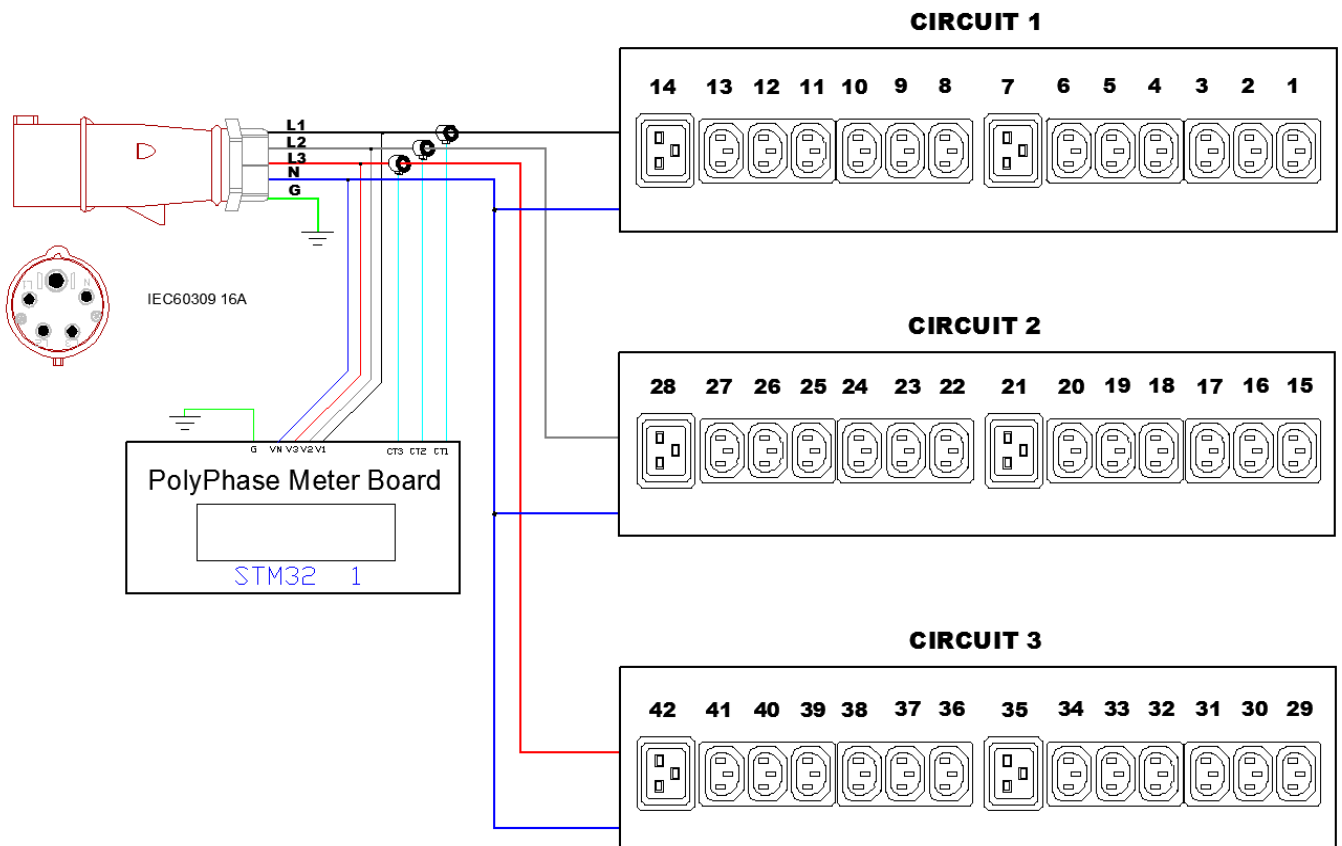

Mechanical Diagram

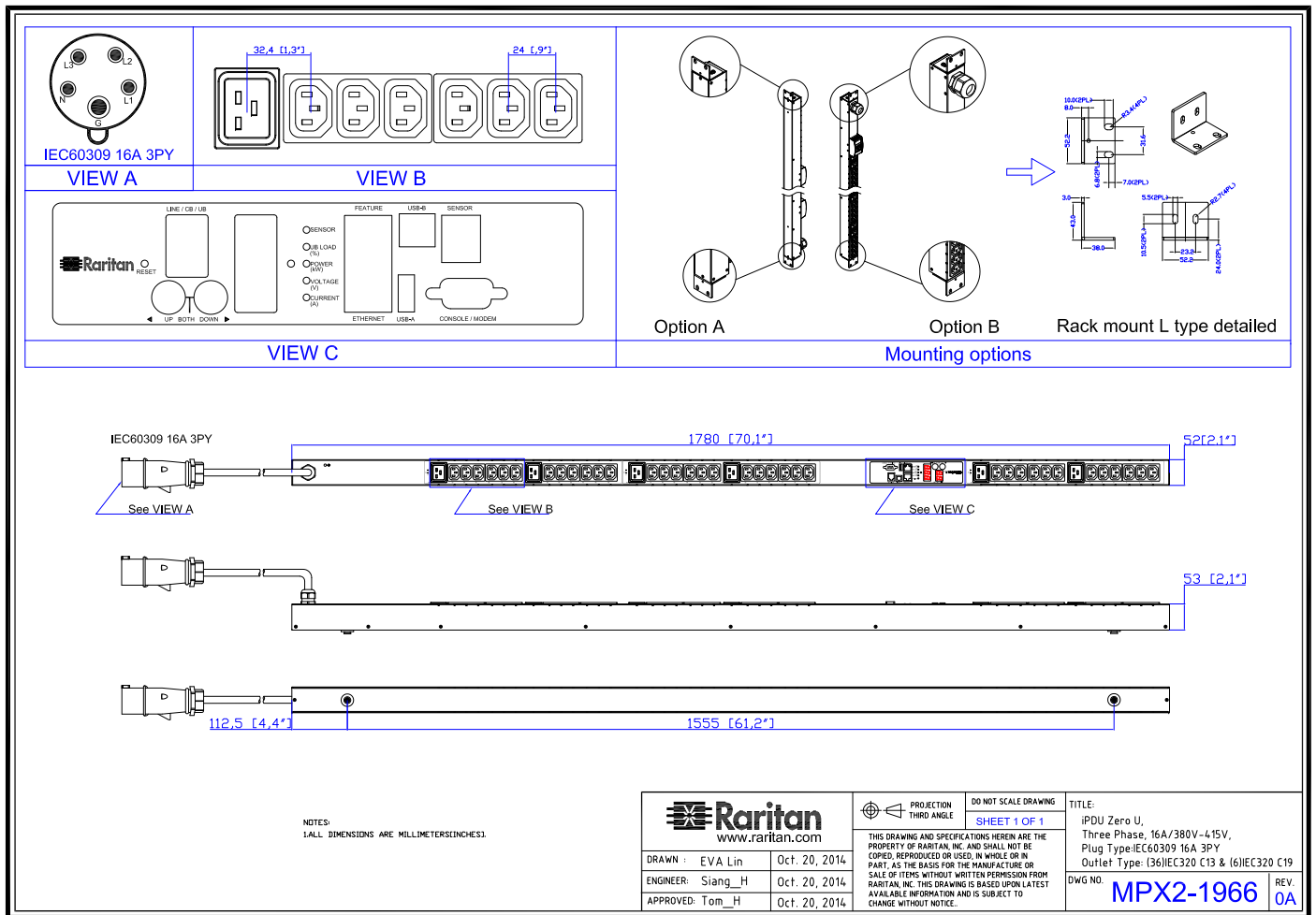

Compatible Sensors

Environmental	DPX-T1 : single temperature node DPX-T2H2 : 2 nodes: each providing both temp + humidity DPX-T3H1 : 3 temperature nodes; one also with humidity DPX-TDP1 : temperature + differential air pressure DPX-AF1 : air flow sensor DPX-CC2-TR : Dual contact closure sensor
----------------------	--

©2015 Raritan Inc. All rights reserved. Raritan®, Know More. Manage Smarter.TM, Dominion® and PX® are registered trademarks or trademarks of Raritan Inc. or its wholly owned subsidiaries. All others are registered trademarks or trademarks of their respective owners. For more information, please visit www.raritan.com