

Technical Specification

Raritan PX
Model Number: PX2-2162R

100-120V
16A
1.6-1.9KVA



Line Drawing

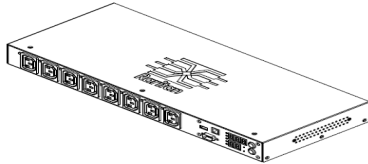

Features

Energy Metering	Voltage (V), Current (A), Active Power (kW), Real Power (kVA), Energy (kWh), Power Factor
Metering Accuracy	ISO/IEC 62053-21 1%
Metering per Input Line	Yes
Metering per Branch Circuit Breaker	Yes
Metering per Output Receptacle	No
Remote Outlet Switching	Yes
Environmental Sensor Ready	Yes
Networking	10/100 BaseT Ethernet. Optional WiFi (802.11a/b/g/n)
Remote Management	HTTP(s); SSH; Telnet; RS-232 (Serial); Power IQ; SNMP version v2/v3; SMTP; JSON-RPC
Cascading	Yes up to (4) PDUs in a single cabinet can share a single Ethernet connection
Onboard Display	3-digit user-selectable display (can be selected between Manual and Auto Display Mode). Can display Line voltage, Line current, CB Current (if IPDU supports CBs) and Unit active power
Compatible Sensors	Temperature, Humidity, Air Flow, Static Pressure Single cable connection provides temp/humidity monitoring at three points in cabinet (with a single sensor assembly)

Input

Input Plug	NEMA 5-20P IP44("splashproof") (120V, Single phase) 
Cord Length	3 meters (9.84 feet) standard
Cord Entry	Bottom-front feed
Cable Type	2P 3W
Number of Power Cords	1
Maximum Input Current	20A (per line)
Rated Input	16A (per line) (North America)
Nominal Input Voltage	120V, Single phase
Rated Input Voltage	100 - 120V, Single phase
Input Frequency	50/60Hz
Power Capacity	1.6kVA at 100V, 1.9kVA at 120V

Output

Nominal Output Voltage	120V
Rated Output Voltage	100 - 120V
Output Connections	(8) IEC 60320 C13 2-pole, 3-wire; 12A (regulatory derated from 15A)
Overload Protection	N/A
Cable Retention	Raritan SecureLock™ Ready Optional retention clips are also available

Physical

Dimensions (W x D x H)	17.3" x 7.2" x 1.7" ; 440.00mm x 183.00mm x 43.80mm
Color	Black powder coat
Mounting	100-89-8430-00

Environmental

Operating Environment	5 - 60°C (41 - 140°F)
Operating Relative Humidity	5-85%
Operating Elevation	0-10000ft

Conformance

Regulatory Approvals	UL Listed Canada ICES-003, Class A Part 15 Class A of the FCC rules RoHS compliant
----------------------	---

Control Panel Detail



Electrical Drawing Detail

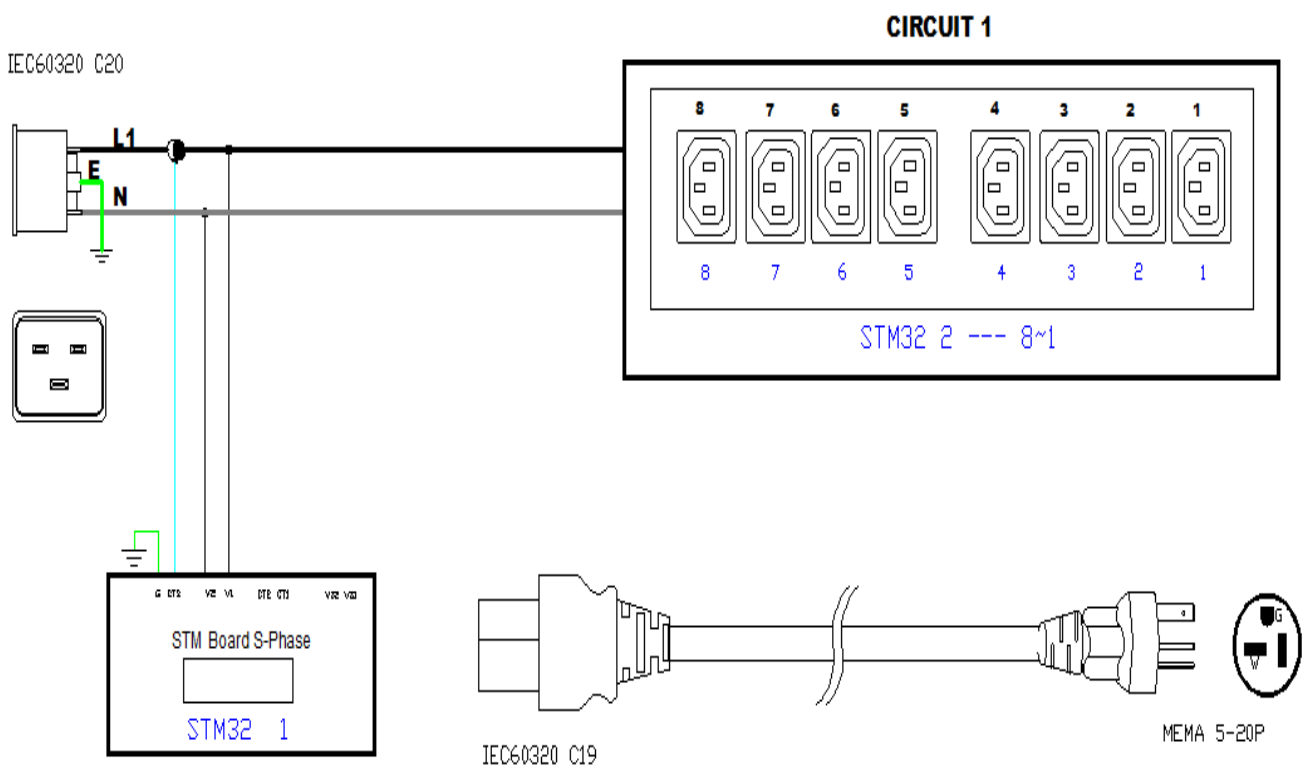

Mechanical Diagram

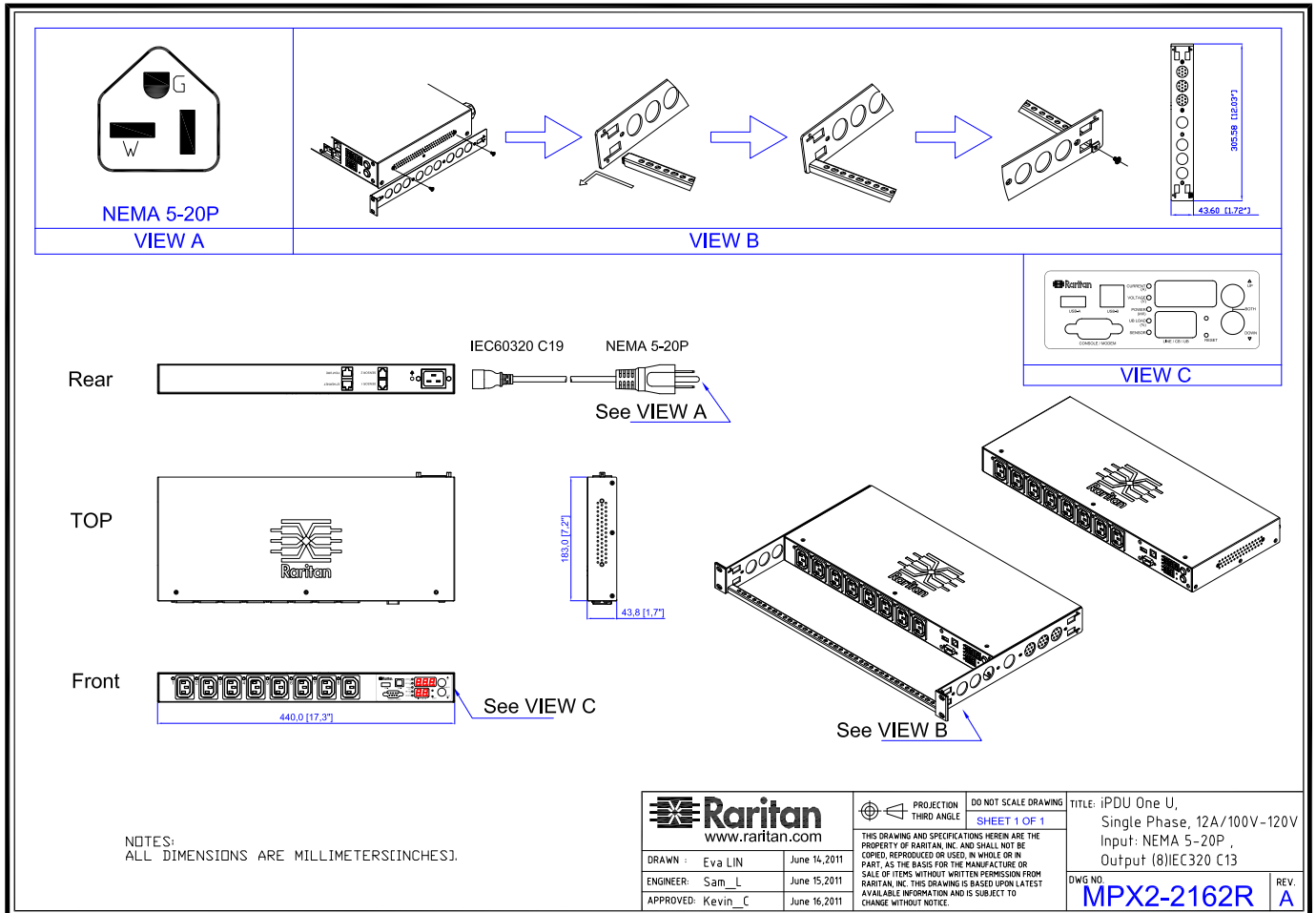

Compatible Sensors

Environmental	DPX-T1 : single temperature node DPX-T2H2 : 2 nodes: each providing both temp + humidity DPX-T3H1 : 3 temperature nodes; one also with humidity DPX-TDP1 : temperature + differential air pressure DPX-AF1 : air flow sensor DPX-CC2-TR : Dual contact closure sensor
----------------------	--

©2015 Raritan Inc. All rights reserved. Raritan®, Know More. Manage Smarter.TM, Dominion® and PX® are registered trademarks or trademarks of Raritan Inc. or its wholly owned subsidiaries. All others are registered trademarks or trademarks of their respective owners. For more information, please visit www.raritan.com