

# Technical Specification

Raritan PX  
Model Number: PX2-2732N

380-415V 3Ø  
16A  
10.6-11.5KVA



## Line Drawing



## Features

Energy Metering	Voltage (V), Current (A), Active Power (kW), Real Power (kVA), Energy (kWh), Power Factor
Metering Accuracy	ISO/IEC 62053-21 1%
Metering per Input Line	Yes
Metering per Branch Circuit Breaker	Yes
Metering per Output Receptacle	No
Remote Outlet Switching	Yes
Environmental Sensor Ready	Yes
Networking	10/100 BaseT Ethernet. Optional WiFi (802.11a/b/g/n)
Remote Management	HTTP(s); SSH; Telnet; RS-232 (Serial); Power IQ; SNMP version v2/v3; SMTP; JSON-RPC
Cascading	Yes up to (4) PDUs in a single cabinet can share a single Ethernet connection
Onboard Display	3-digit user-selectable display (can be selected between Manual and Auto Display Mode). Can display Line voltage, Line current, CB Current (if IPDU supports CBs) and Unit active power, and Unbalanced Current percentage
Compatible Sensors	Temperature, Humidity, Air Flow, Static Pressure Single cable connection provides temp/humidity monitoring at three points in cabinet (with a single sensor assembly)

## Input

Input Plug	Cord (400V, 3 phase)
Cord Length	3 meters (9.84 feet) standard
Cord Entry	Bottom-front feed
Cable Type	4P 5W
Number of Power Cords	1
Maximum Input Current	16A (per line)
Nominal Input Voltage	400V, 3 phase
Rated Input Voltage	380 - 415V, 3 phase
Input Frequency	50/60Hz
Power Capacity	10.6kVA at 380V, 11.5kVA at 415V

## Output

Nominal Output Voltage	230V
Rated Output Voltage	220 - 240V
Output Connections	a. (24) IEC 60320 C13 2-pole, 3-wire; 10A b. (12) IEC 60320 C19 2-pole, 3-wire; 16A
Overload Protection	N/A
Cable Retention	Raritan SecureLock™ Ready Optional retention clips are also available

## Physical

Dimensions (W x D x H)	2.1" x 2.6" x 70.1" ; 52.20mm x 65.30mm x 1780.00mm
Color	Black powder coat
Mounting	G2-RACK-FOR-ZU

## Environmental

Operating Environment	5 - 50°C (41 - 122°F)
Operating Relative Humidity	5-85%
Operating Elevation	0-10000ft

## Conformance

Regulatory Approvals	CE Canada ICES-003, Class A Part 15 Class A of the FCC rules RoHS compliant
----------------------	--

## Control Panel Detail



## Electrical Drawing Detail

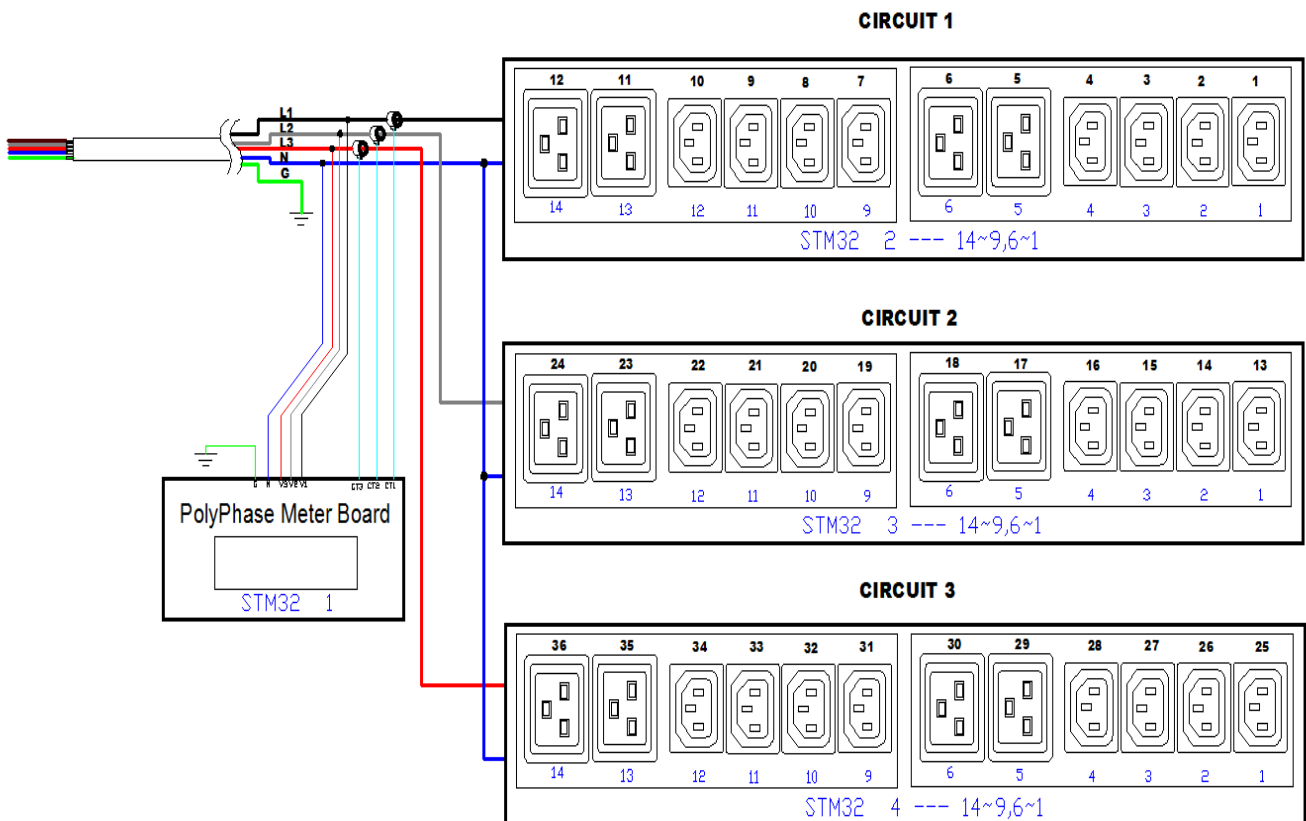

# Mechanical Diagram

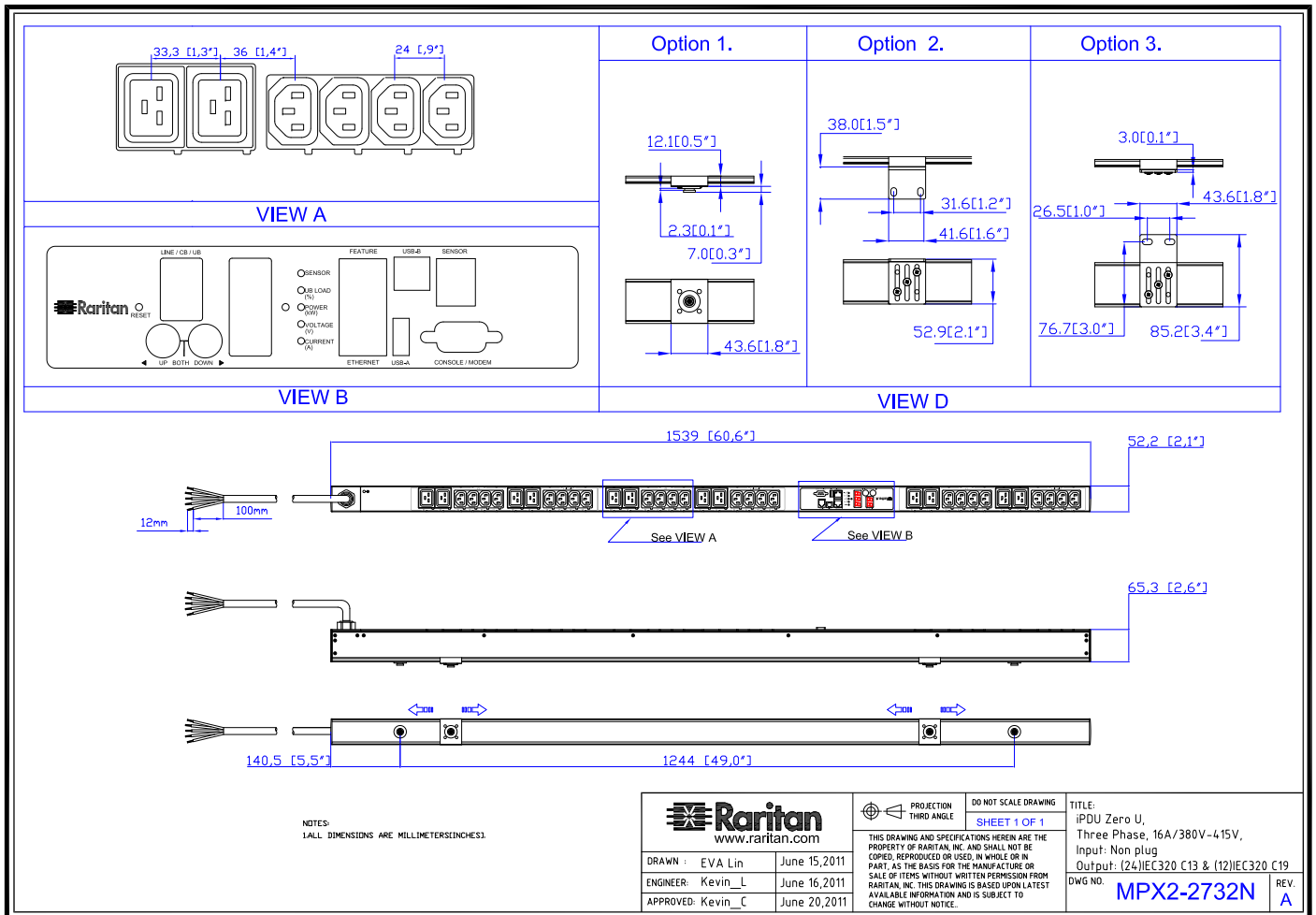

# Mounting Diagram (G2-RACK-FOR-ZU)

250-70-0104-00



250-80-0011-00

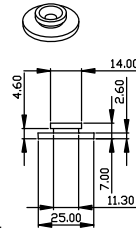

250-70-0007-00

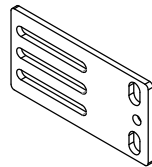
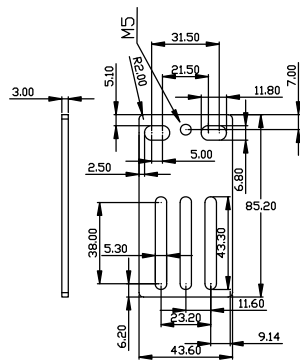

250-70-0093-00

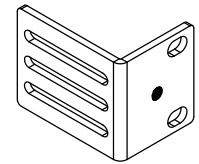
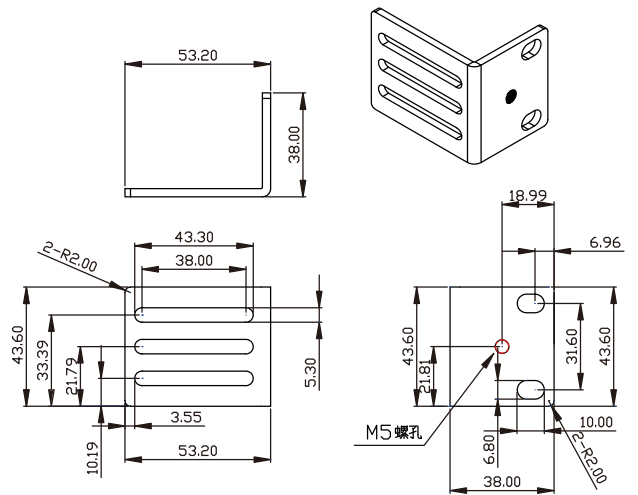

## Compatible Sensors

<b>Environmental</b>	DPX-T1 : single temperature node DPX-T2H2 : 2 nodes: each providing both temp + humidity DPX-T3H1 : 3 temperature nodes; one also with humidity DPX-TDP1 : temperature + differential air pressure DPX-AF1 : air flow sensor DPX-CC2-TR : Dual contact closure sensor
----------------------	--

©2015 Raritan Inc. All rights reserved. Raritan®, Know More. Manage Smarter.TM, Dominion® and PX® are registered trademarks or trademarks of Raritan Inc. or its wholly owned subsidiaries. All others are registered trademarks or trademarks of their respective owners. For more information, please visit [www.raritan.com](http://www.raritan.com)