

# Technical Specification

Raritan PX  
Model Number: PX2-4721

190-208V 3Ø  
24A  
7.9-8.6KVA



## Line Drawing



## Features

Energy Metering	Voltage (V), Current (A), Active Power (kW), Real Power (kVA), Energy (kWh), Power Factor
Metering Accuracy	ISO/IEC 62053-21 1%
Metering per Input Line	Yes
Metering per Branch Circuit Breaker	Yes
Metering per Output Receptacle	Yes
Remote Outlet Switching	No
Environmental Sensor Ready	Yes
Networking	10/100 BaseT Ethernet. Optional WiFi (802.11a/b/g/n)
Remote Management	HTTP(s); SSH; Telnet; RS-232 (Serial); Power IQ; SNMP version v2/v3; SMTP; JSON-RPC
Cascading	Yes up to (4) PDUs in a single cabinet can share a single Ethernet connection
Onboard Display	3-digit user-selectable display (can be selected between Manual and Auto Display Mode). Can display Line voltage, Line current, CB Current (if IPDU supports CB), Unit active power, Unbalanced Current percentage (if 3 phase IPDU), Outlet Voltage, Outlet Current, and Outlet Active power
Compatible Sensors	Temperature, Humidity, Air Flow, Static Pressure Single cable connection provides temp/humidity monitoring at three points in cabinet (with a single sensor assembly)

## Input

Input Plug	NEMA L21-30P IP44("splashproof") (208V, 3 phase) 
Cord Length	3 meters (9.84 feet) standard
Cord Entry	Bottom-front feed
Cable Type	3P 4W
Number of Power Cords	1
Maximum Input Current	30A (per line)
Rated Input	24A (per line) (North America)
Nominal Input Voltage	208V, 3 phase
Rated Input Voltage	190 - 208V, 3 phase
Input Frequency	50/60Hz
Power Capacity	7.9kVA at 190V, 8.6kVA at 208V

## Output

Nominal Output Voltage	208V
Rated Output Voltage	190 - 208V
Output Connections	a. (30) IEC 60320 C13 2-pole, 3-wire; 12A (regulatory derated from 15A) b. (6) IEC 60320 C19 2-pole, 3-wire; 16A (regulatory derated from 20A)
Overload Protection	(3) 20A 2-pole LEGBX66-20 circuit breaker
Cable Retention	Raritan SecureLock™ Ready Optional retention clips are also available

## Physical

Dimensions (W x D x H)	2.1" x 2.6" x 70.1" ; 52.20mm x 65.30mm x 1780mm
Color	Black powder coat
Mounting	G2-RACK-FOR-ZU

## Environmental

Operating Environment	5 - 60°C (41 - 140°F)
Operating Relative Humidity	5-85%
Operating Elevation	0-10000ft

## Conformance

Regulatory Approvals	UL Listed Canada ICES-003, Class A Part 15 Class A of the FCC rules RoHS compliant
----------------------	---

## Control Panel Detail



## Electrical Drawing Detail

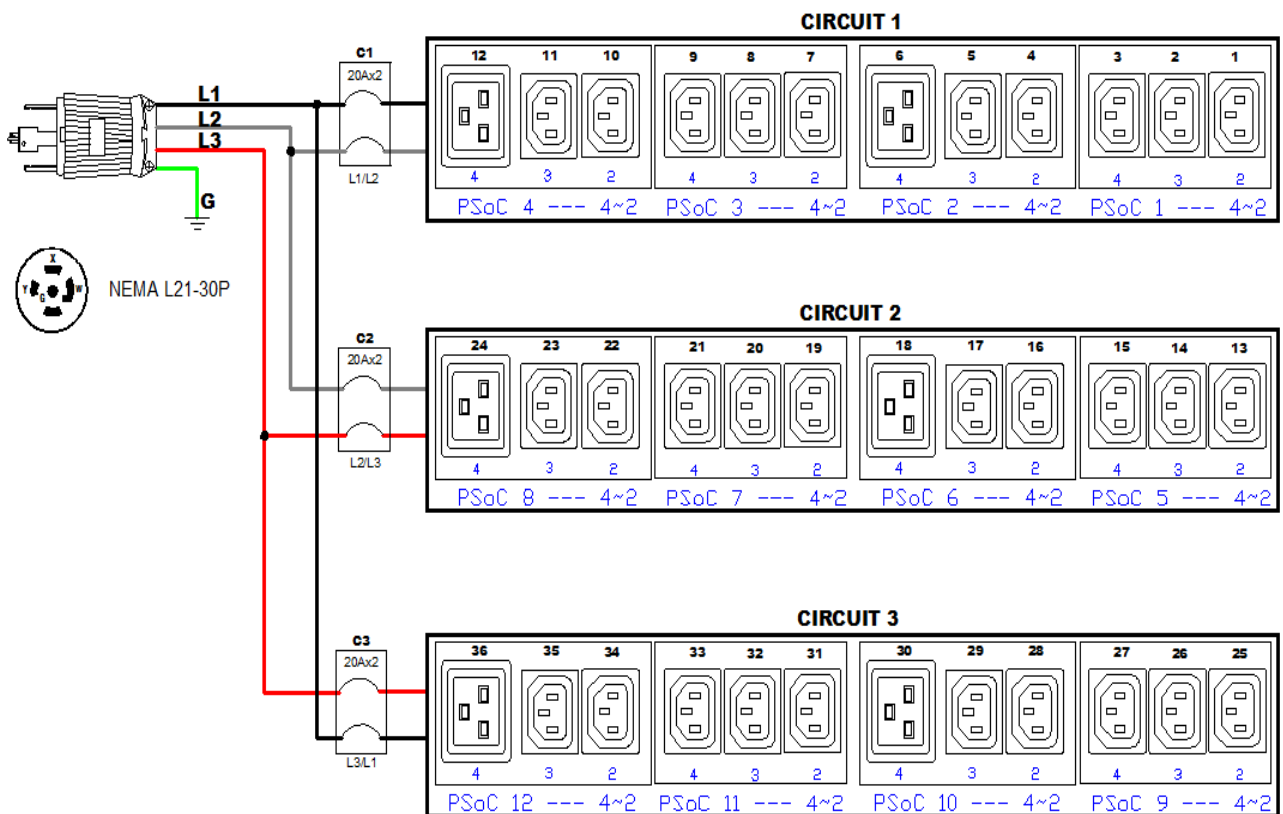

# Mechanical Diagram

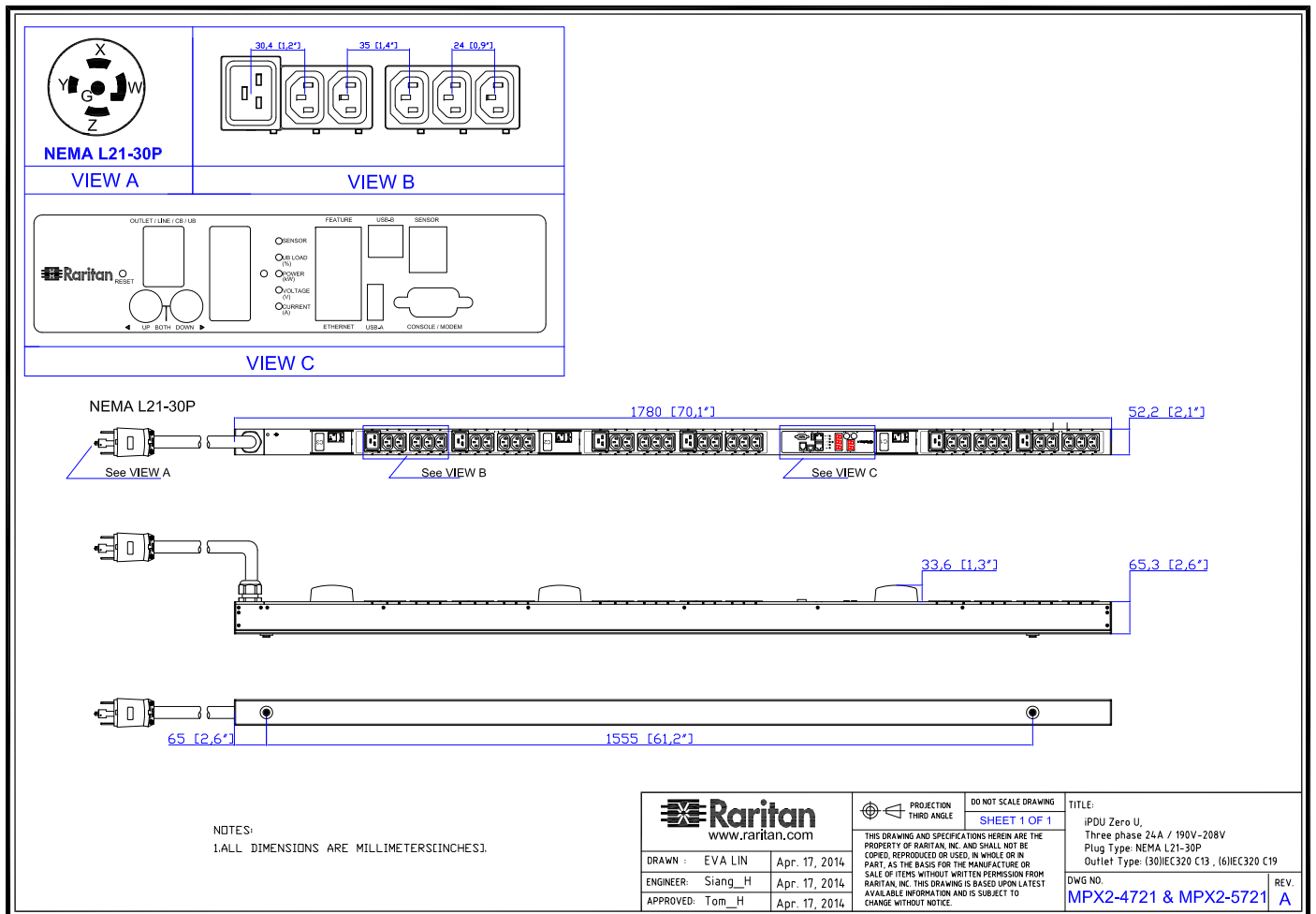

# Mounting Diagram (G2-RACK-FOR-ZU)

250-70-0104-00

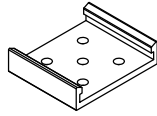

250-80-0011-00



250-70-0007-00

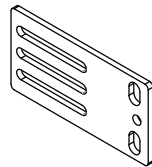
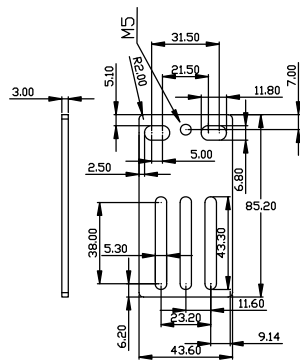

250-70-0093-00

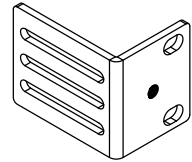
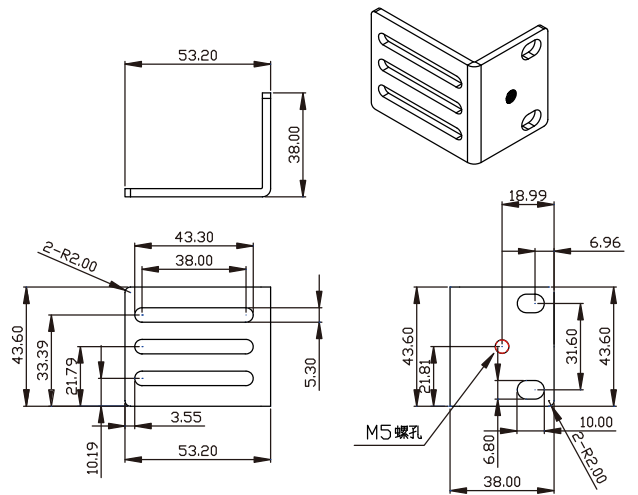

## Compatible Sensors

Environmental	DPX-T1 : single temperature node DPX-T2H2 : 2 nodes: each providing both temp + humidity DPX-T3H1 : 3 temperature nodes; one also with humidity DPX-TDP1 : temperature + differential air pressure DPX-AF1 : air flow sensor DPX-CC2-TR : Dual contact closure sensor
---------------	--

## Trip Curve of Circuit Breaker

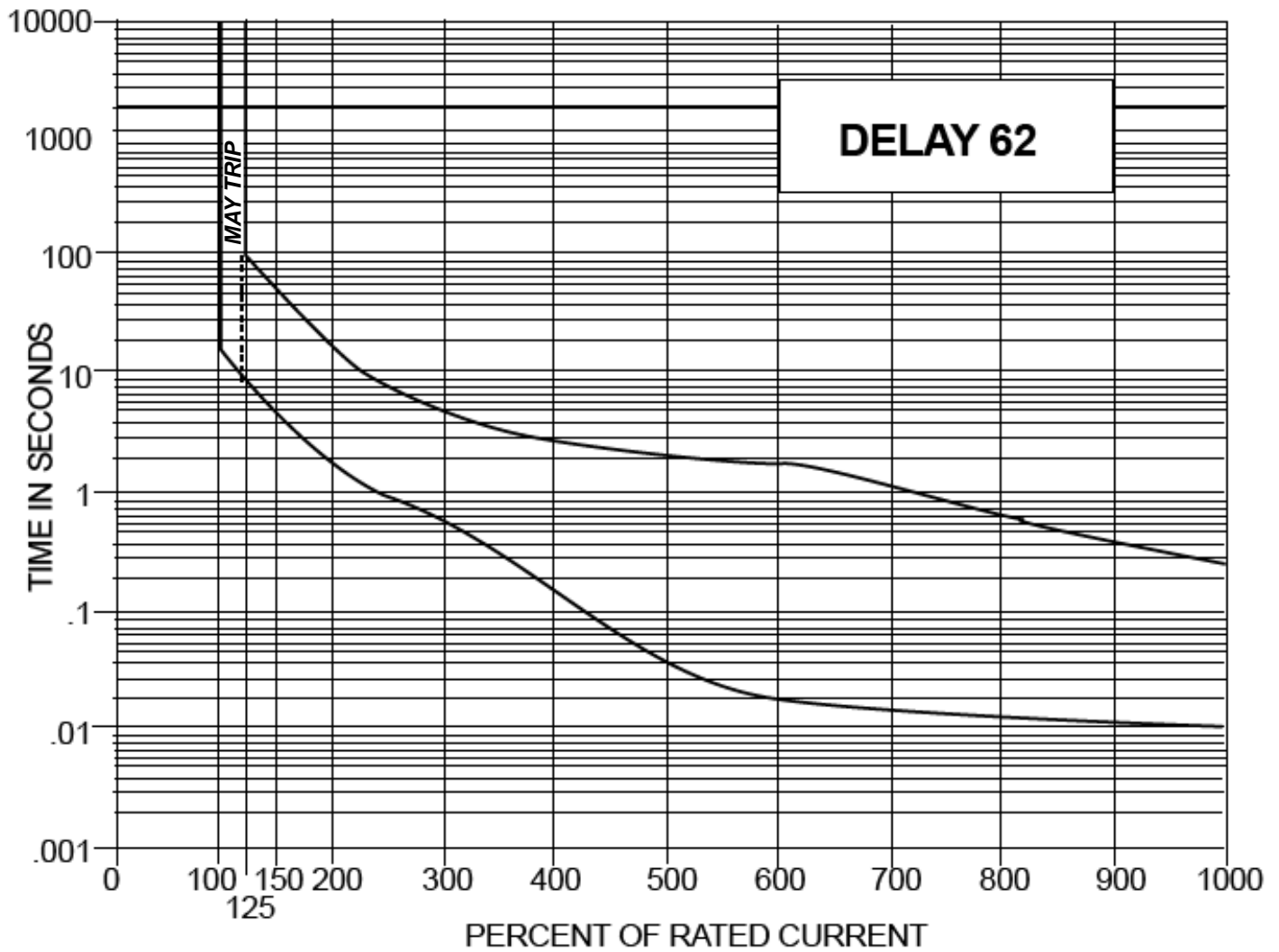

©2015 Raritan Inc. All rights reserved. Raritan®, Know More. Manage Smarter.TM, Dominion® and PX® are registered trademarks or trademarks of Raritan Inc. or its wholly owned subsidiaries. All others are registered trademarks or trademarks of their respective owners. For more information, please visit [www.raritan.com](http://www.raritan.com)