

Technical Specifications / Engineering Submittals

Raritan Model Number: PX2-1146R

rev20200925

LINE DRAWING

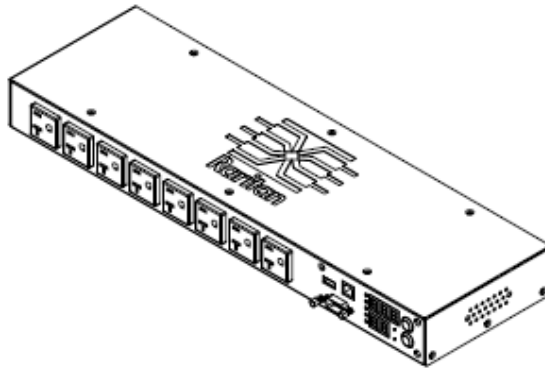

FEATURES

Energy Metering	Voltage (V), Current (A), Active Power (kW), Real Power (kVA), Energy (kWh), Power Factor
Metering Accuracy	ISO/IEC 62053-21 1%
Metering per Input Line	Yes
Metering per Branch Circuit Breaker	No
Metering per Output Receptacle	No
Remote Outlet Switching	No
Environmental Sensor Ready	Yes
Replaceable Controller	No
Compatible Sensors	Temperature, Humidity, Air Flow, Differential Pressure, Water Leak, and Contact Closure
Networking	(10/100 BaseT) Ethernet port. Optional WiFi (802.11a/b/g/n)
Remote Management	HTTP(s); SSH; Telnet; RS-232 (Serial); Power IQ; SNMP version v2/v3; SMTP; JSON-RPC
Cascading	Yes, Max 8 PDUs can be daisy chained using USB connection
Onboard Display	3-digit LED user-selectable display : Voltage, current, or active power (per line)
Embedded Processor	ARM9 400MHZ (Atmel SAM9G20), 16MB NOR Flash, 64MB SDRAM

Technical Specifications / Engineering Submittals

Raritan Model Number: PX2-1146R

rev20200925

INPUT

Input Plug	NEMA 5-20P (2P3W)
Cord Length	3 meters (9.84 feet) standard
Cord Entry	Rear feed
Cable Type	IP44("splashproof")
Number of Power Cords	1
Maximum Input Current	20A
Nominal Input Voltage	120V
Rated Input Voltage	100 - 120V
Input Frequency	50/60Hz
Power Capacity	1.6kVA at 100V, 1.9kVA at 120V

OUTPUT

Nominal Output Voltage	120V
Rated Output Voltage	100 - 120V
Receptacles (Output Connections)	(8) NEMA 5-20R, 16A
Securelock Support	No
Cord Retention	No
Overload Protection	N/A

PHYSICAL

Color	Black powder coat (custom colors available)
Unit Dimensions (WxDxH)	17.3" x 5.2" x 1.7" ; 440mm x 133mm x 44mm
Unit Weight	2 kg
Shipping Weight	5 kg
Shipping Dimensions (WxDxH)	22.05" x 10.59" x 12.4" ; 560mm x 269mm x 315mm
Mounting	RACK-KIT-PX2-1K-1U

Technical Specifications / Engineering Submittals

Raritan Model Number: PX2-1146R

rev20200925

ENVIRONMENTAL

Operating Temperature	60°C
Operating Relative Humidity	85%
Operating Elevation	0-10000ft

CONFORMANCE

Regulatory Approvals	UL Listed, Canada ICES-003, Part 15 Class A of the FCC rules, RoHS compliant
Warranty	Standard 2 years manufacturer warranty

Technical Specifications / Engineering Submittals

Raritan Model Number: PX2-1146R

rev20200925

CONTROL PANEL

Dimension: 111.5mm x 40.5mm

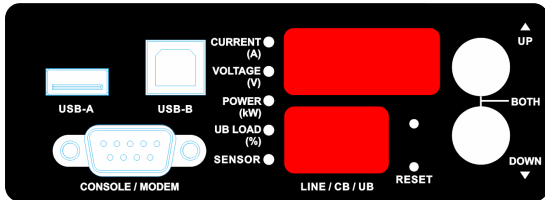

Technical Specifications / Engineering Submittals

Raritan Model Number: PX2-1146R

rev20200925

ELECTRICAL (ONE LINE) DIAGRAM

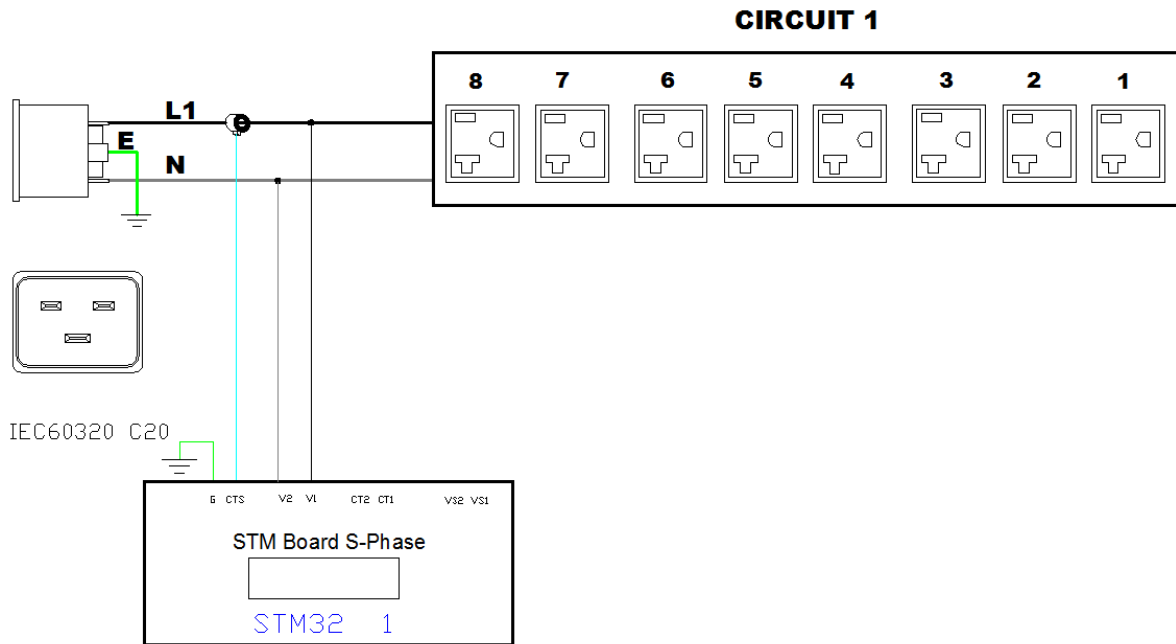

Technical Specifications / Engineering Submittals

Raritan Model Number: PX2-1146R

rev20200925

MECHANICAL DIAGRAM

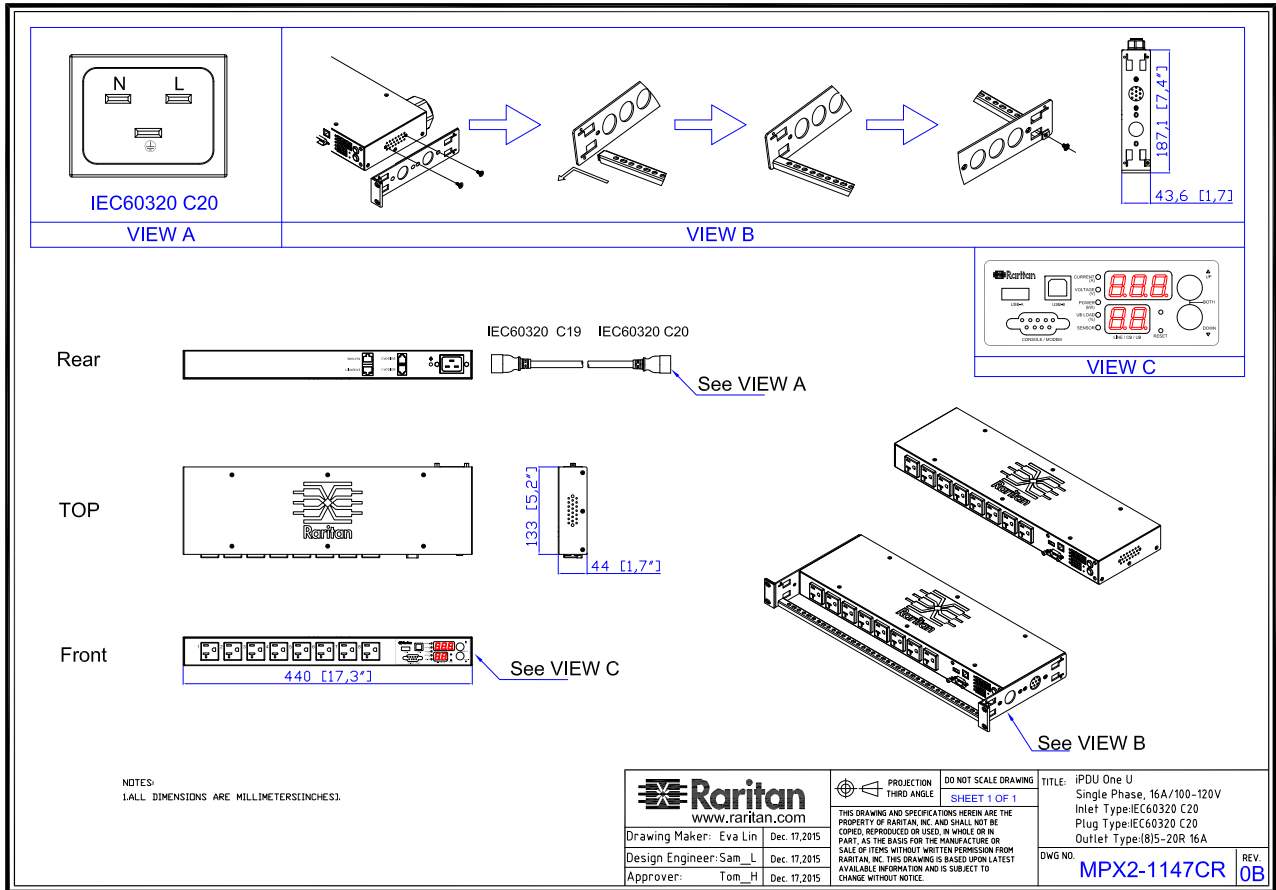

Technical Specifications / Engineering Submittals
Raritan Model Number: PX2-1146R

rev20200925

TRIP CURVE

This file generated on: Fri, September 25, 2020 - 15:37:38