

NEMA L21-30P

VIEW A

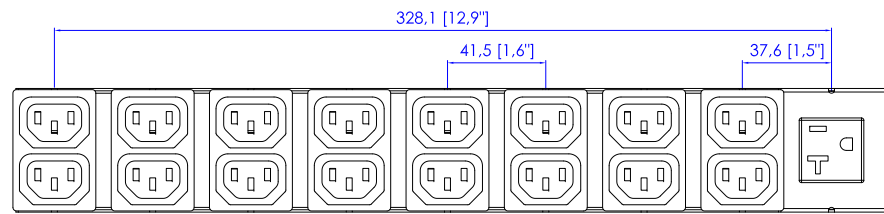

VIEW B

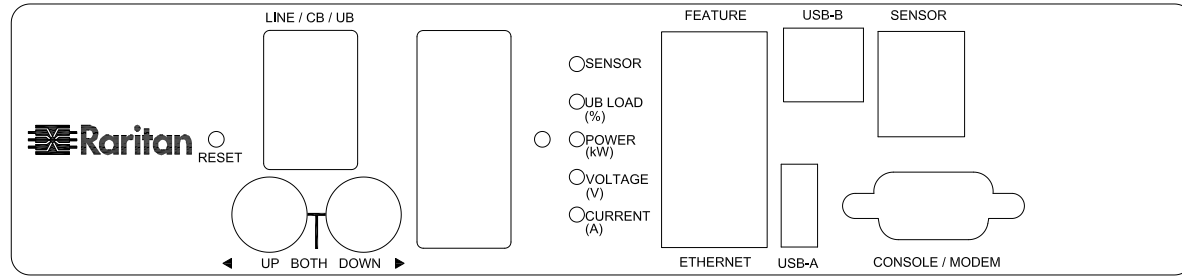

VIEW C

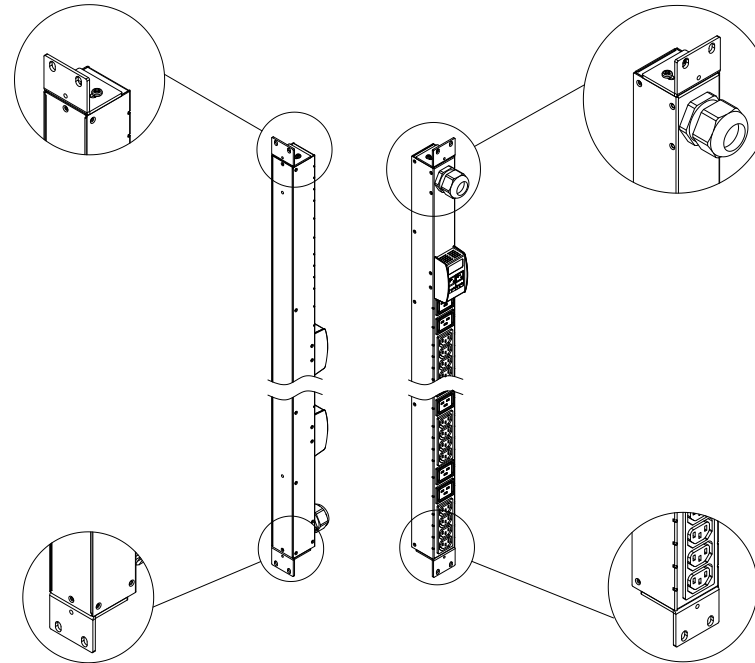

Option A

Option B

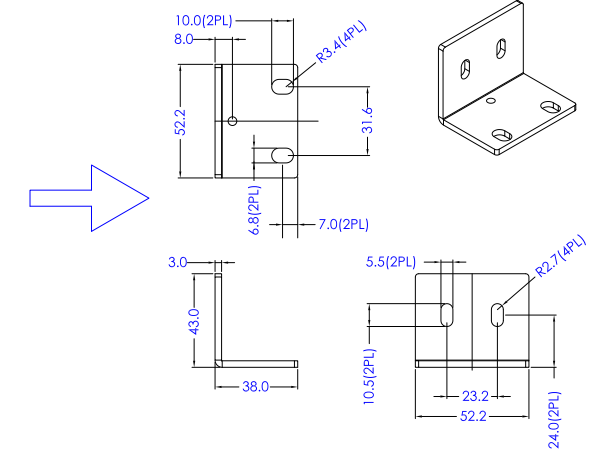

Rack mount L type detailed

Mounting options

NEMA L21-30P

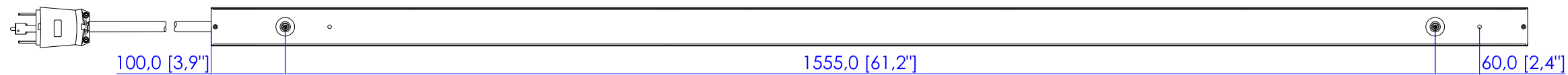
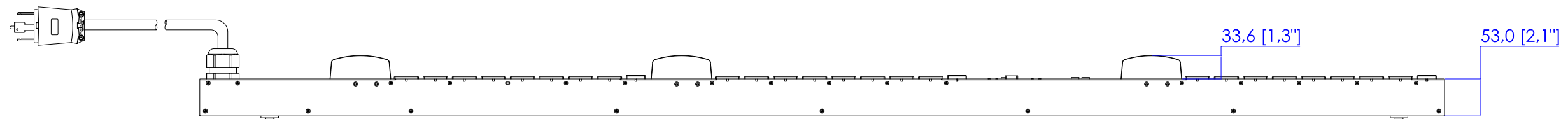
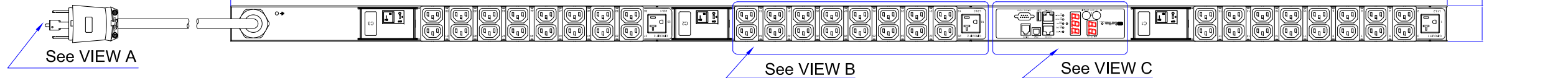

NOTES:

1. ALL DIMENSIONS ARE MILLIMETERS [INCHES].



DO NOT SCALE DRAWING

SHEET 1 OF 1

THIS DRAWING AND SPECIFICATIONS HEREIN ARE THE PROPERTY OF RARITAN, INC. AND SHALL NOT BE COPIED, REPRODUCED OR USED, IN WHOLE OR IN PART, AS THE BASIS FOR THE MANUFACTURE OR SALE OF ITEMS WITHOUT WRITTEN PERMISSION FROM RARITAN, INC. THIS DRAWING IS BASED UPON LATEST AVAILABLE INFORMATION AND IS SUBJECT TO CHANGE WITHOUT NOTICE.

TITLE: iPDU Zero U,  
Three phase 24A / 190V-208V  
Plug Type: NEMA L21-30P  
Outlet Type: 190V-208V (4)IEC320 C13  
110V-120V (3)NEMA 5-20R

DWG NO.

MPX2-1972

REV.

A

DRAWN :	EVA LIN	Aug. 14, 2013
ENGINEER:	Kenny_C	Aug. 14, 2013
APPROVED:	Tom_H	Aug. 14, 2013