

NEMA L6-30P

VIEW A

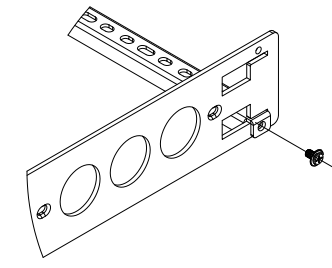
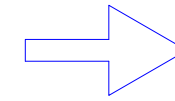
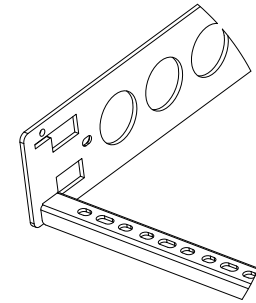
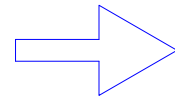
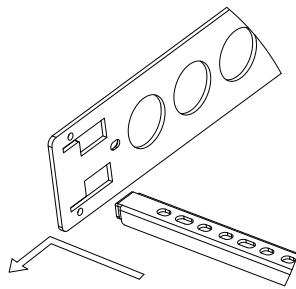
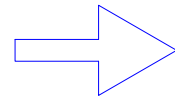
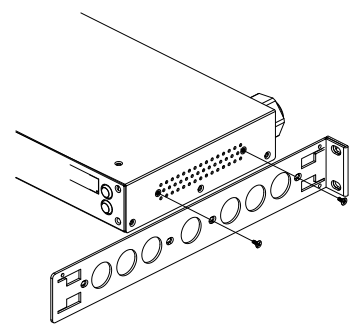

43.6 [1,7"]

305.6 [12.0"]

VIEW B

Rear

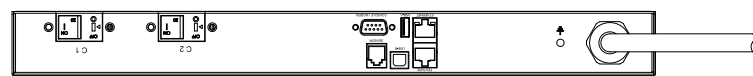

NEMA L6-30P

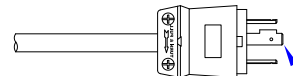

See VIEW A

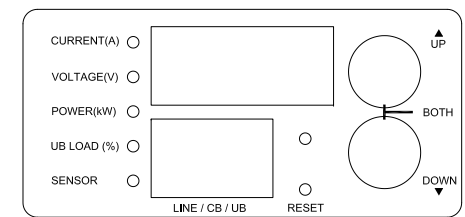

VIEW C

TOP

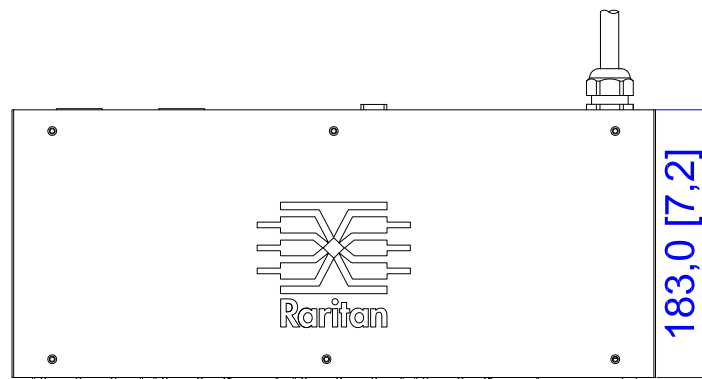

183,0 [7,2]

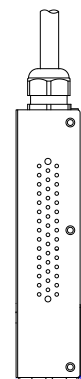

43,8 [1,7]

440,0 [17,3]

Front

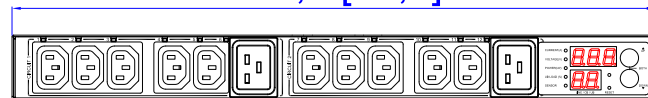

See VIEW C

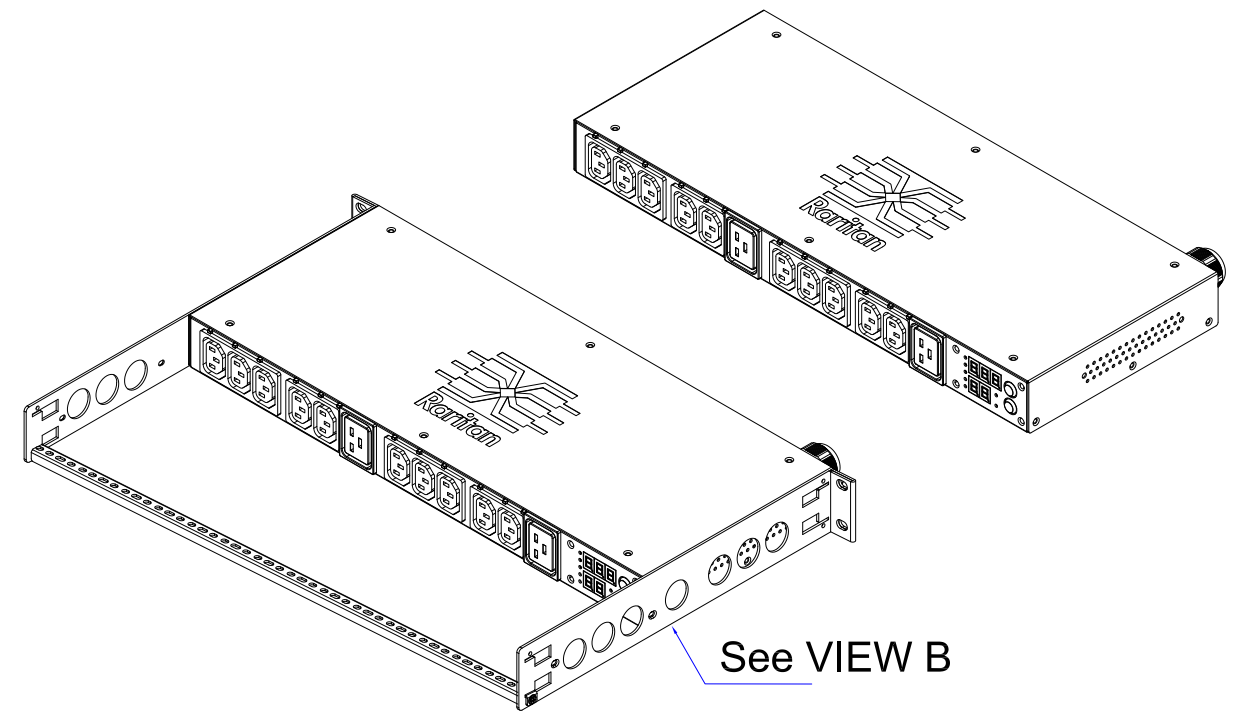

See VIEW B

NOTES:

1.ALL DIMENSIONS ARE MILLIMETERS[INCHES].



PROJECTION
THIRD ANGLE

DO NOT SCALE DRAWING

SHEET 1 OF 1

THIS DRAWING AND SPECIFICATIONS HEREIN ARE THE PROPERTY OF RARITAN, INC. AND SHALL NOT BE COPIED, REPRODUCED OR USED, IN WHOLE OR IN PART, AS THE BASIS FOR THE MANUFACTURE OR SALE OF ITEMS WITHOUT WRITTEN PERMISSION FROM RARITAN, INC. THIS DRAWING IS BASED UPON LATEST AVAILABLE INFORMATION AND IS SUBJECT TO CHANGE WITHOUT NOTICE.

TITLE: iPDU One U,
Single Phase, 24A/200-240V
Input: NEMA L6-30P
Output (6)IEC320 C13 & (2)IEC320 C19

DWG NO. **MPX2-2288R-N1** REV. **A**

DRAWN : Eva Lin Aug. 26, 2013
ENGINEER: Sam_L Aug. 26, 2013
APPROVED: Tom_H Aug. 26, 2013