

NEMA L15-30P

VIEW A

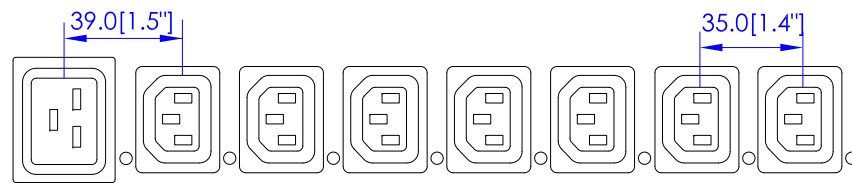

VIEW B

Option 1.

Option 2.

Option 3.

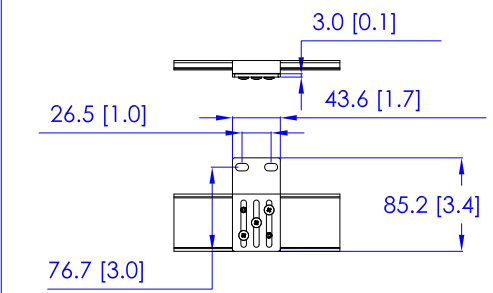
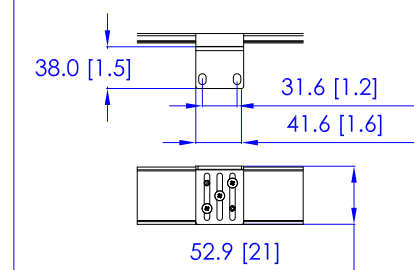
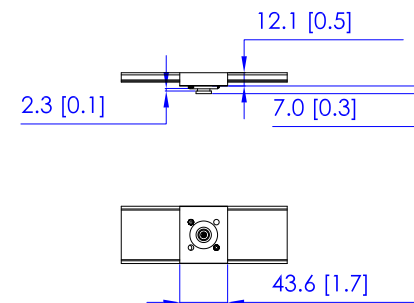

VIEW D

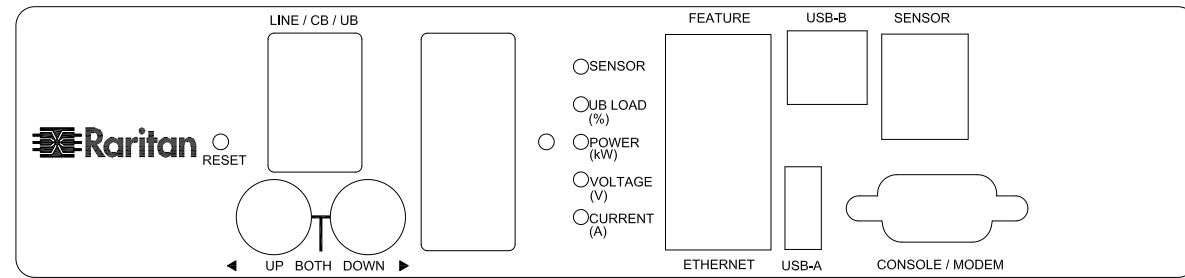

VIEW C

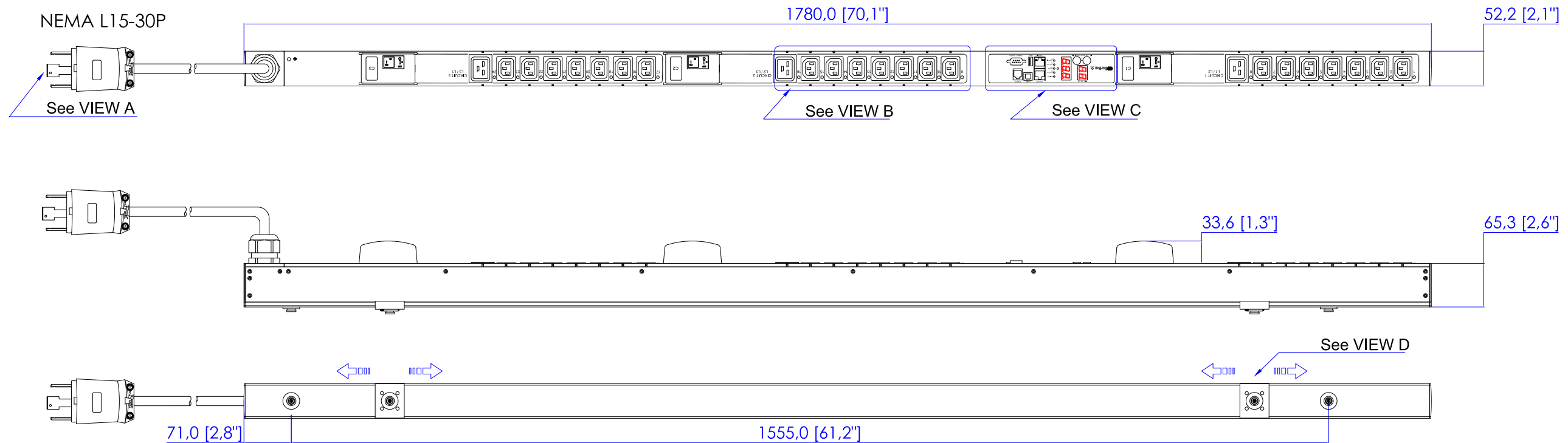

NOTES:
1. ALL DIMENSIONS ARE MILLIMETERS [INCHES].



DRAWN : EVA LIN June 15, 2011
ENGINEER: Kenny_C June 16, 2011
APPROVED: Kevin_C June 20, 2011

PROJECTION THIRD ANGLE
DO NOT SCALE DRAWING
SHEET 1 OF 1

THIS DRAWING AND SPECIFICATIONS HEREIN ARE THE PROPERTY OF RARITAN, INC. AND SHALL NOT BE COPIED, REPRODUCED OR USED, IN WHOLE OR IN PART, AS THE BASIS FOR THE MANUFACTURE OR SALE OF ITEMS WITHOUT WRITTEN PERMISSION FROM RARITAN, INC. THIS DRAWING IS BASED UPON LATEST AVAILABLE INFORMATION AND IS SUBJECT TO CHANGE WITHOUT NOTICE.

TITLE:
iPDU Zero U,
Three phase 24A / 208V-240V
Input : NEMA L15-30P
Output : (21)IEC320 C13 , (3)IEC320 C19

DWG NO. **MPX2-2523** REV. **A**