

Rear

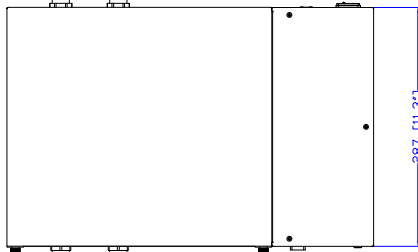

IEC60309 32A

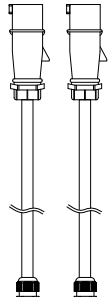

Top

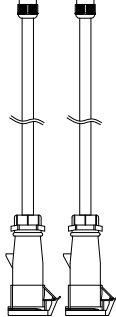

IEC60309 32A R

Front

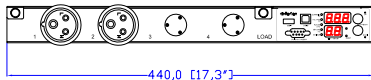

See VIEW A

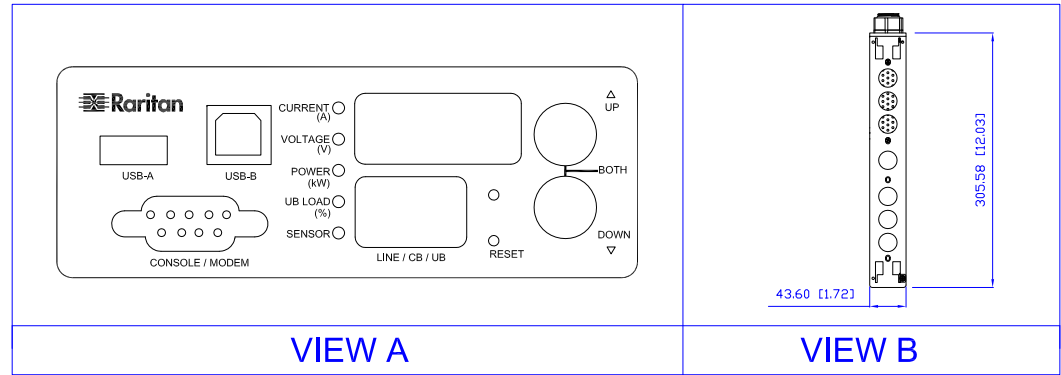
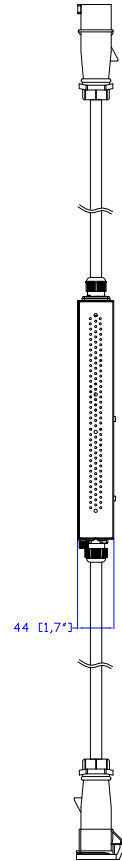

VIEW A

VIEW B

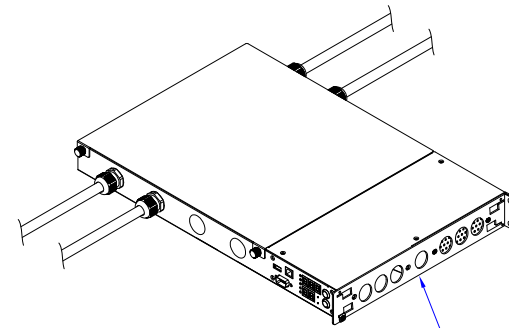

See VIEW B

NOTES:  
ALL DIMENSIONS ARE MILLIMETERS[INCHES].

 www.raritan.com	 PROJECTION THIRD ANGLE	DO NOT SCALE DRAWING <b>SHEET 1 OF 1</b>	TITLE: iPDU One U Single Phase, 32A/200V-240V Input Plugs: (2)IEC60309 32A Output Plugs: (2)IEC60309 32A R
	DRAWN : Tom Hsueh    Nov. 07.2014 ENGINEER: Tom Hsueh    Nov. 07.2014 APPROVED: Tom Hsueh    Nov. 07.2014	THIS DRAWING AND SPECIFICATIONS HEREIN ARE THE PROPERTY OF RARITAN, INC. AND SHALL NOT BE COPIED, REPRODUCED OR USED, IN WHOLE OR IN PART, AS THE BASIS FOR THE MANUFACTURE OR SALE OF ITEMS WITHOUT WRITTEN PERMISSION FROM RARITAN, INC. THIS DRAWING IS BASED UPON LATEST AVAILABLE INFORMATION AND IS SUBJECT TO CHANGE WITHOUT NOTICE.	