

NEMA L21-30P

VIEW A

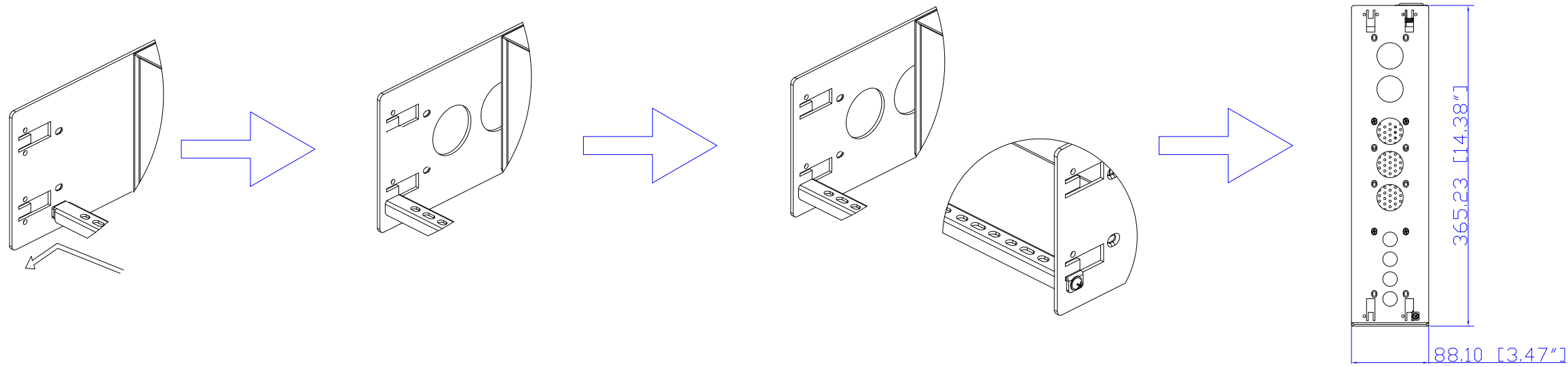

VIEW B

Rear

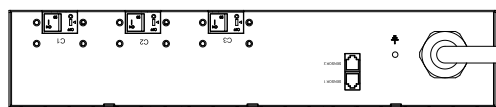

NEMA L21-30P

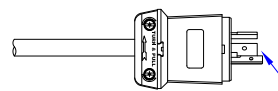

See VIEW A

TOP

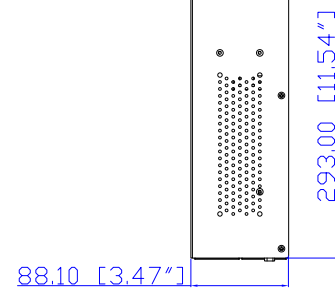
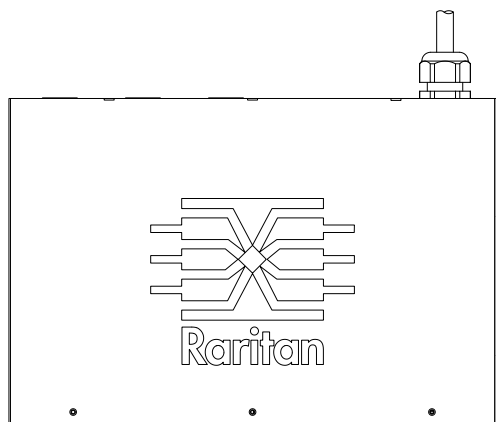

Front

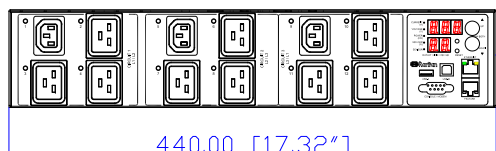

See VIEW C

NOTES:
ALL DIMENSIONS ARE MILLIMETERS[INCHES].

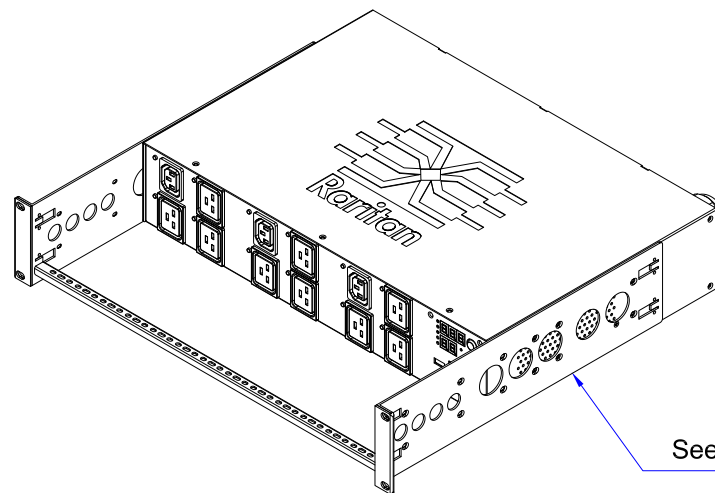
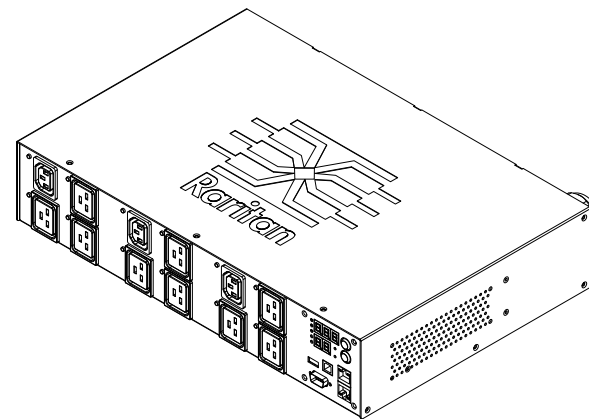

See VIEW B

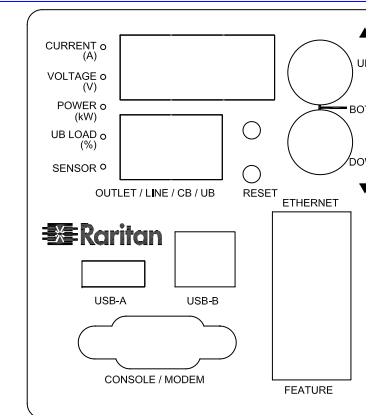

VIEW C



PROJECTION
THIRD ANGLE

DO NOT SCALE DRAWING

SHEET 1 OF 1

THIS DRAWING AND SPECIFICATIONS HEREIN ARE THE PROPERTY OF AMERICAN POWER CONVERSION AND SHALL NOT BE COPIED, REPRODUCED OR USED IN WHOLE OR IN PART, AS THE BASIS FOR THE MANUFACTURE OR SALE OF ITEMS WITHOUT WRITTEN PERMISSION FROM APC. THIS DRAWING IS BASED UPON LATEST AVAILABLE INFORMATION AND IS SUBJECT TO CHANGE WITHOUT NOTICE.

TITLE:
iPDU Two U,
Three phase, 24 A/190V-208V
Plug Type: NEMA L21-30P
Outlet Type : (3) IEC320 C13, (9) IEC 320 C19

DWG NO.
MPX2-4761R & MPX2-5761R

REV.
A

DRAWN :	EvaLin	Nov., 05, 2012
ENGINEER:	Siang_H	Nov., 05, 2012
APPROVED:	Tom_H	Nov., 05, 2012