

Rear

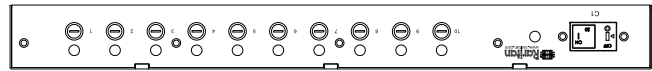

TOP

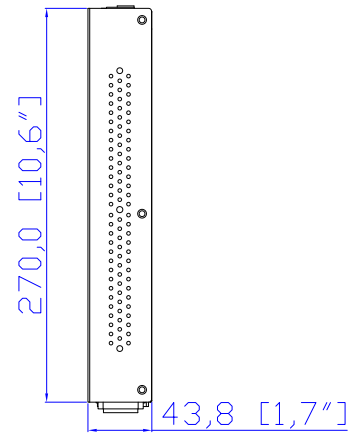

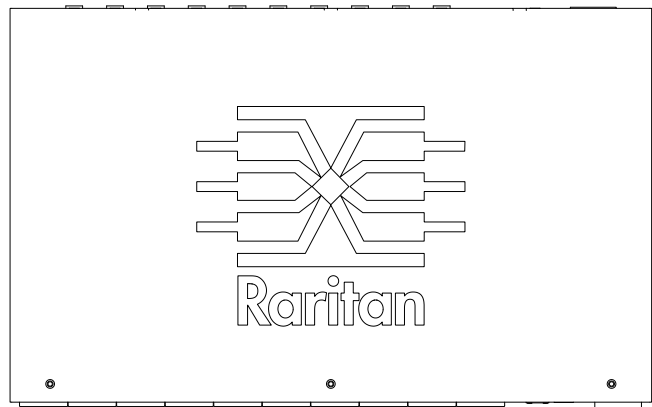

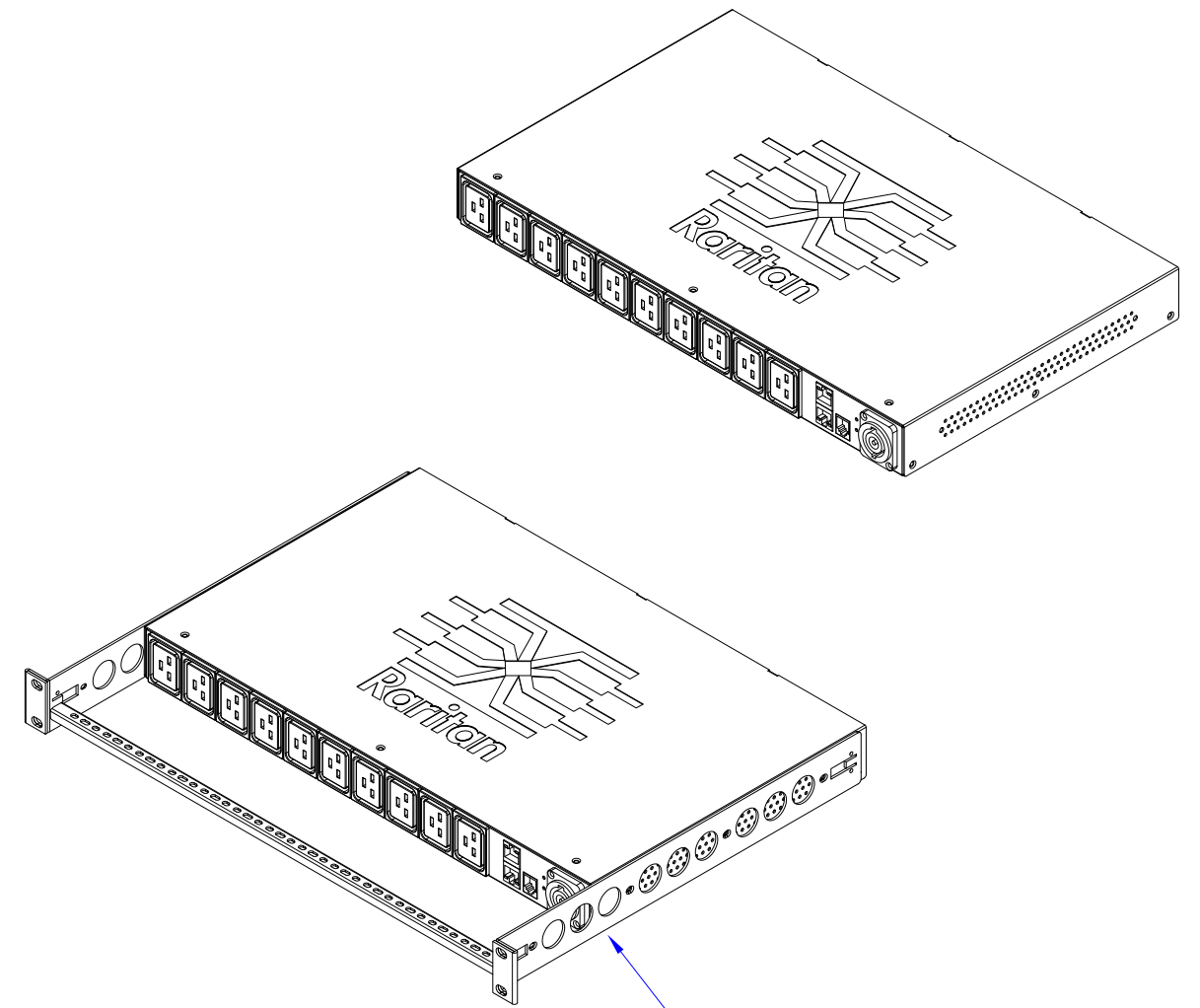
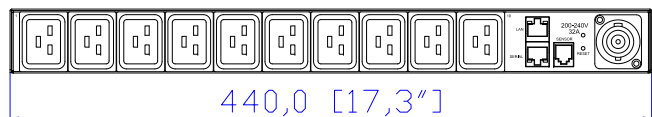
Front



See VIEW A

NOTES:
ALL DIMENSIONS ARE MILLIMETERS[INCHES].

| | | | |
|---|---|---|---|
|  www.raritan.com |  PROJECTION THIRD ANGLE | DO NOT SCALE DRAWING SHEET 1 OF 1 | TITLE: iPDU One U, Single Phase, 32A/200V-240V Input: powerCON 32A , Output: (10) IEC320 C19 / 16A |
| | THIS DRAWING AND SPECIFICATIONS HEREIN ARE THE PROPERTY OF RARITAN, INC. AND SHALL NOT BE COPIED, REPRODUCED OR USED, IN WHOLE OR IN PART, AS THE BASIS FOR THE MANUFACTURE OR SALE OF ITEMS WITHOUT WRITTEN PERMISSION FROM RARITAN, INC. THIS DRAWING IS BASED UPON LATEST AVAILABLE INFORMATION AND IS SUBJECT TO CHANGE WITHOUT NOTICE. | | |
| DRAWN : Eva Lin Aug. 25, 2011 ENGINEER: Kenny_C Aug. 25, 2011 APPROVED: Tom_H Aug. 25, 2011 | | | REV. A |