

NEMA L21-30P

VIEW A

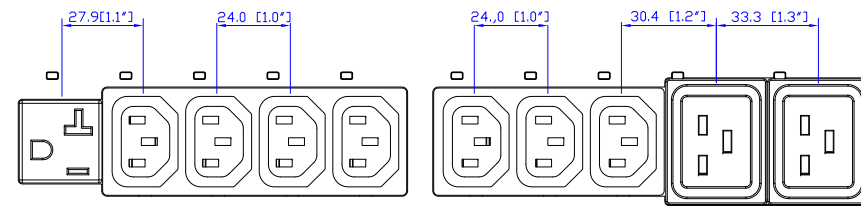

VIEW B

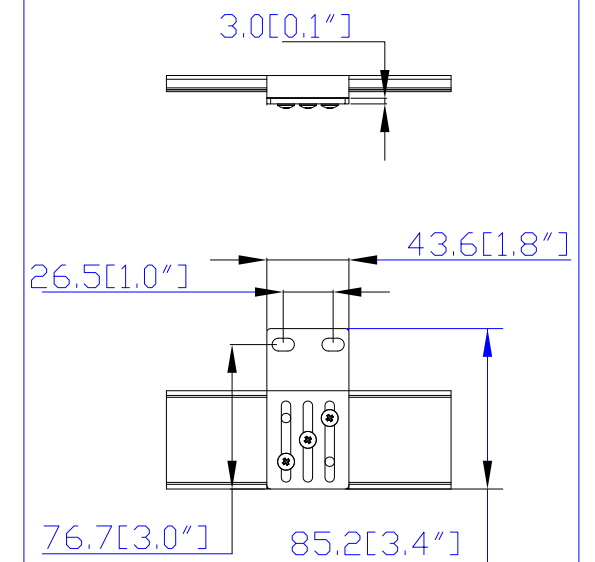
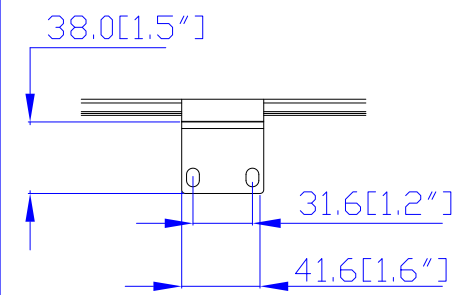
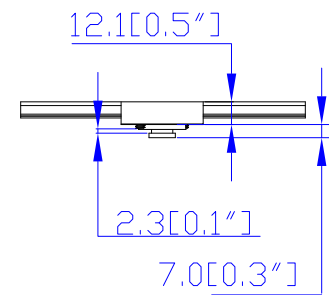

VIEW D

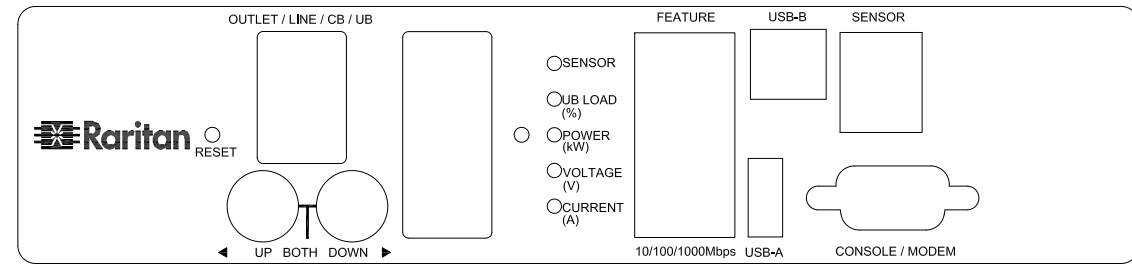

VIEW C

NEMA L21-30P

1780.0 [70.1"]

52.2 [2.1"]

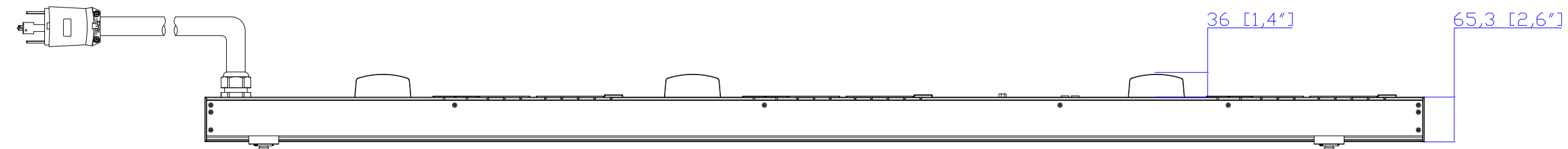
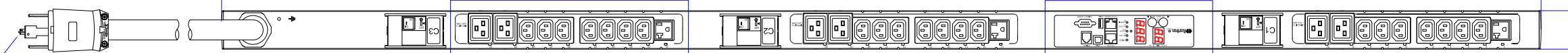

NOTES:  
1. ALL DIMENSIONS ARE MILLIMETERS [INCHES].



PROJECTION THIRD ANGLE  
DO NOT SCALE DRAWING  
SHEET 1 OF 1

THIS DRAWING AND SPECIFICATIONS HEREIN ARE THE PROPERTY OF RARITAN, INC. AND SHALL NOT BE COPIED, REPRODUCED OR USED, IN WHOLE OR IN PART, AS THE BASIS FOR THE MANUFACTURE OR SALE OF ITEMS WITHOUT WRITTEN PERMISSION FROM RARITAN, INC. THIS DRAWING IS BASED UPON LATEST AVAILABLE INFORMATION AND IS SUBJECT TO CHANGE WITHOUT NOTICE.

TITLE:  
iPDU Zero U,  
Three phase 24A / 190V-208V  
Plug Type: NEMA L21-30P  
Outlet Type: 120V: (3)5-20R  
208V: (6)IEC320 C19 , (2)IEC320 C13

DRAWN : EVA LIN Mar. 12, 2013  
ENGINEER: Siang\_H Mar. 12, 2013  
APPROVED: Tom\_H Mar. 12, 2013

DWG NO. MPX2-5660-G1 & MPX2-4660-G1  
REV. A