

NEMA L6-30P

VIEW A

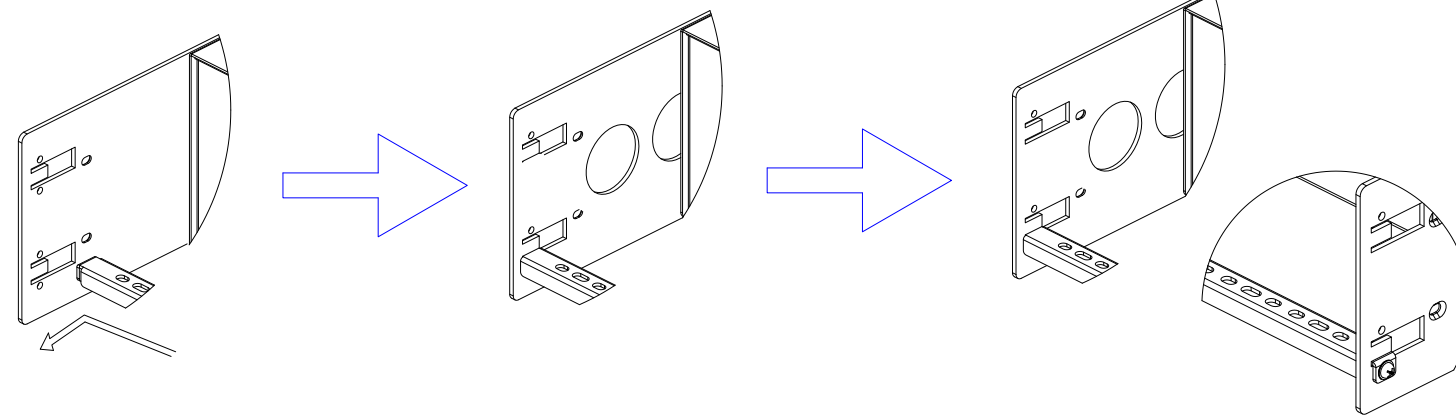

VIEW B

88.10 [3.471"]

365.23 [14.390"]

Rear



NEMA L6-30P

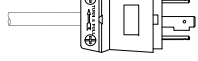

See VIEW A

TOP

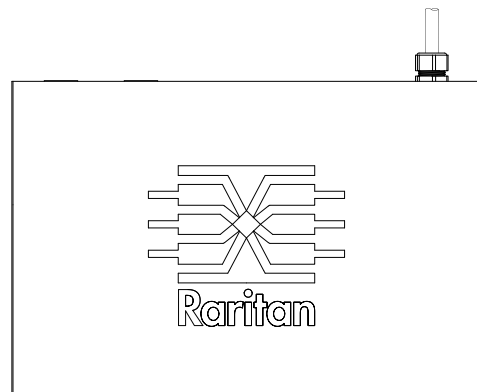

293,0 [11,5"]

88,1 [3,5"]

Front

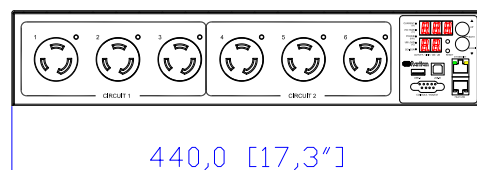

440,0 [17,3"]

See VIEW C

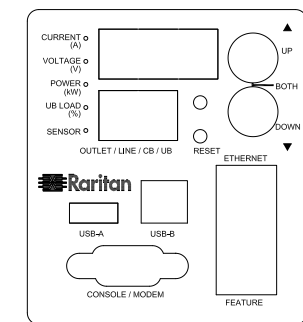

VIEW C

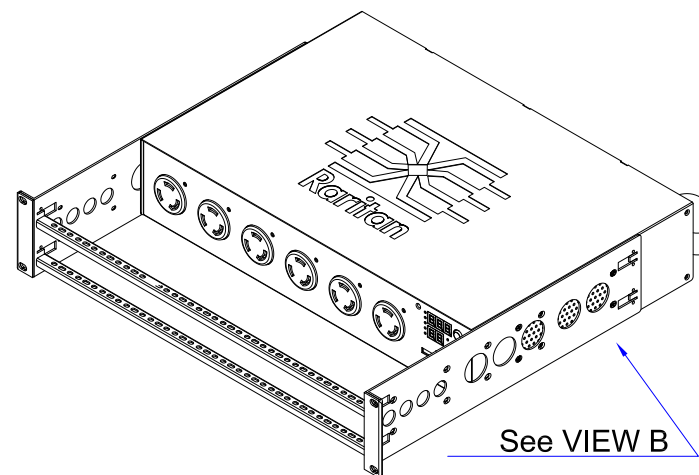

See VIEW B

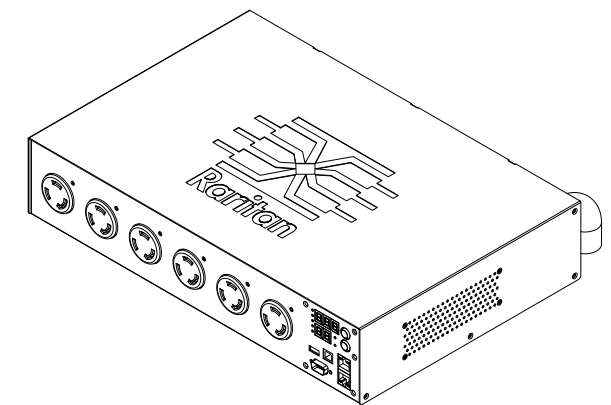

NOTES:
ALL DIMENSIONS ARE MILLIMETERS[INCHES].



PROJECTION
THIRD ANGLE

DO NOT SCALE DRAWING

SHEET 1 OF 1

DRAWN : Eva Lin Jan. 12,2012

ENGINEER: Siang_H Jan. 12,2012

APPROVED: Tom_H Jan. 12,2012

THIS DRAWING AND SPECIFICATIONS HEREIN ARE THE PROPERTY OF RARITAN, INC. AND SHALL NOT BE COPIED, REPRODUCED OR USED, IN WHOLE OR IN PART, AS THE BASIS FOR THE MANUFACTURE OR SALE OF ITEMS WITHOUT WRITTEN PERMISSION FROM RARITAN, INC. THIS DRAWING IS BASED UPON LATEST AVAILABLE INFORMATION AND IS SUBJECT TO CHANGE WITHOUT NOTICE.

TITLE: iPDU Two U,
Single phase, 24A/200V-240V
Input Type:NEMA L6-30P
Output Type:(6)NEMA L6-20R

DWG NO.
MPX2-5810R & MPX2-4810R

REV.
A