

IEC60309 32A

VIEW A

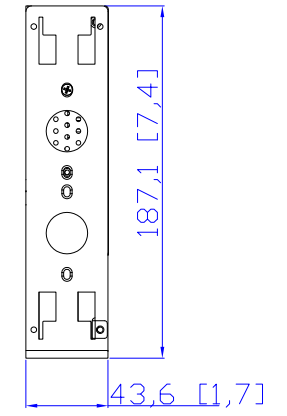
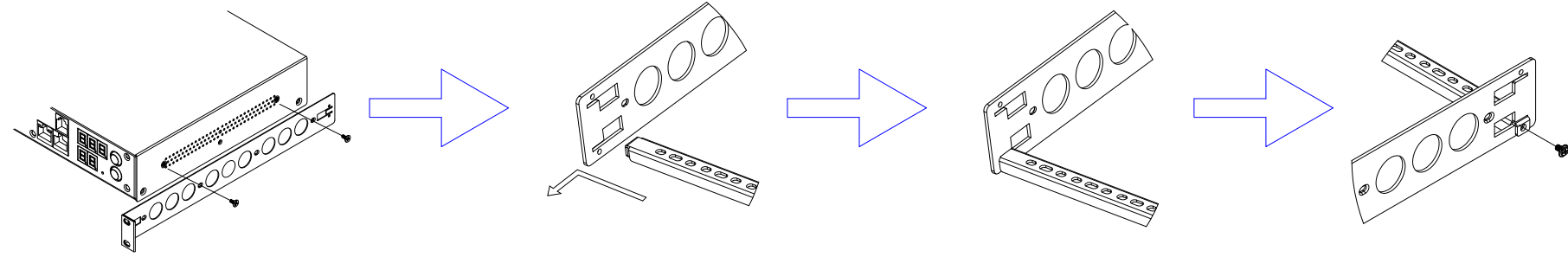

Mounting options

Rear

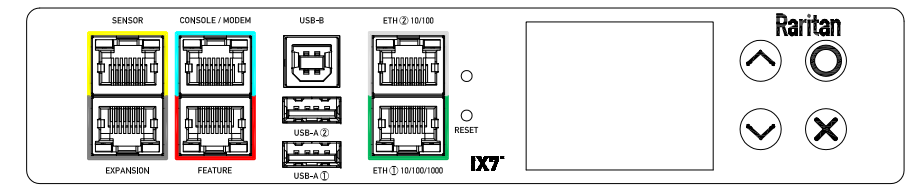
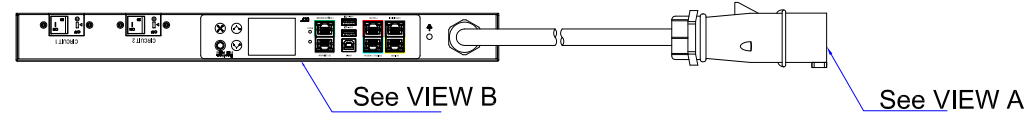

VIEW B

TOP

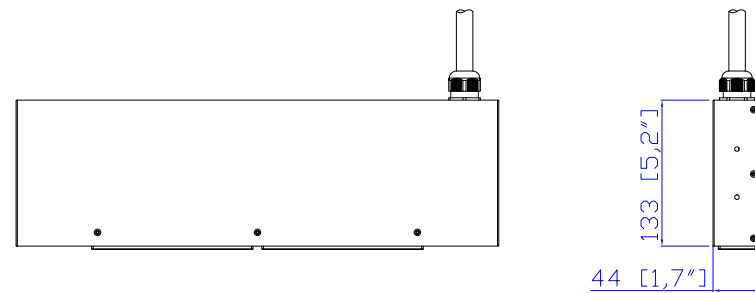

Front

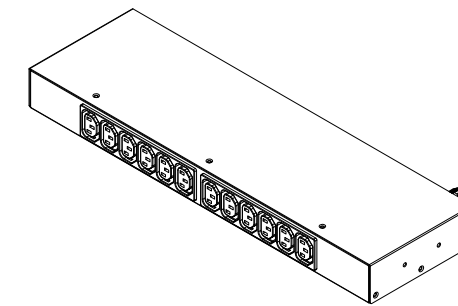
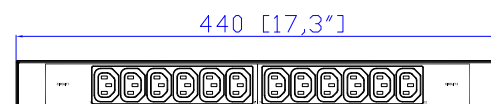

- NOTES:
1. INSTALLATION SHALL COMPLY WITH ALL APPLICABLE NATIONAL, STATE AND LOCAL CODES.
  2. PLEASE REFER TO PRODUCT DOCUMENTATION FOR FURTHER INFORMATION.
  3. UNLESS OTHERWISE SPECIFIED, ALL DIMENSIONS ARE IN MILLIMETERS (INCHES).
  4. MOUNTING BUTTON IS AN ALTERNATIVE MOUNTING METHOD TO THE TOOLLESS MOUNT FOR 3RD PARTY ENCLOSURE. BUTTON IS PROVIDED WITH THE UNIT. DETAILED INSTALLATION INSTRUCTIONS CAN BE FOUND IN THE PROVIDED MANUAL.
  5. BRACKET KITS TO MOUNT TO SPECIFIC 3RD PARTY ENCLOSURES ARE AVAILABLE AS OPTIONS.
  6. LENGTH OF THE CORD IS 3000MM +/- 70MM
  7. DIMENSION TOLERANCE: LENGTH +/- 3MM, WIDTH +/- 1MM, DEPTH +/- 0.5MM
  8. REFER TO THE TABLE FOR DETAIL CORD LENGTH DEFINITION

**Raritan**  
A brand of **Legrand**



THIS DRAWING AND SPECIFICATIONS HEREIN ARE THE PROPERTY OF RARITAN, Inc. AND SHALL NOT BE COPIED, REPRODUCED OR USED, IN WHOLE OR IN PART, AS THE BASIS FOR THE MANUFACTURE OR SALE OF ITEMS WITHOUT WRITTEN PERMISSION FROM RARITAN, Inc. THIS DRAWING IS BASED UPON LATEST AVAILABLE INFORMATION AND IS SUBJECT TO CHANGE WITHOUT NOTICE.

DO NOT SCALE DRAWING  
**SHEET 1 OF 1**

TITLE: iPDU One U  
Single Phase, 32A/200-240V  
Plug Type: IEC60309 32A  
Outlet Type: C13 (12)

Drawing Maker:	Eva Lin	July 24 , 2017
Design Engineer:	Kenny_C	July 24 , 2017
Approver:	Tom_H	July 24 , 2017

DWG NO: MPX3-1292R M5

MODEL NO: **PX3-1292R & PX3-1292R-M5**

REV. **2A**