

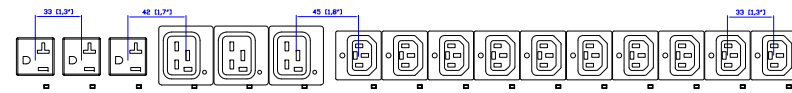

NEMA L14-30P

VIEW A



VIEW B

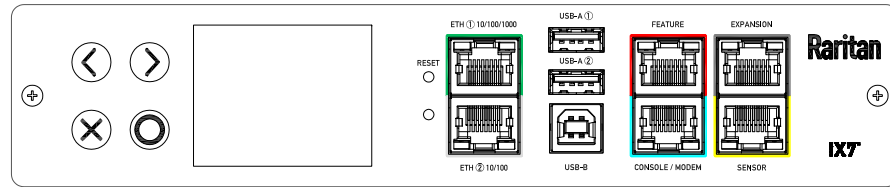

VIEW C

Option 1.

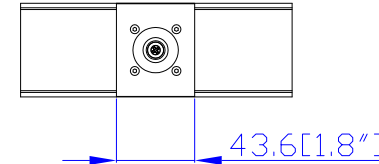
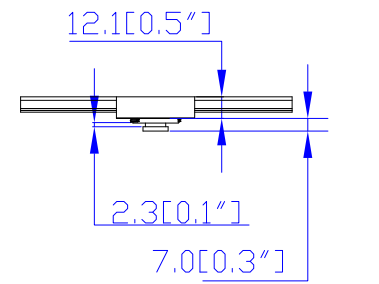

Option 2.

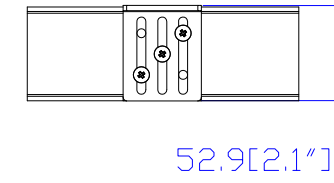
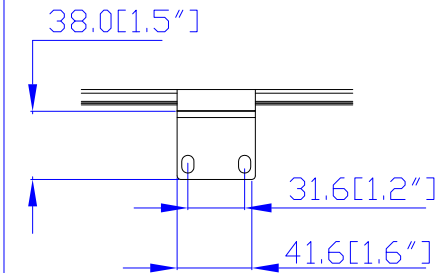

VIEW D

Option 3.

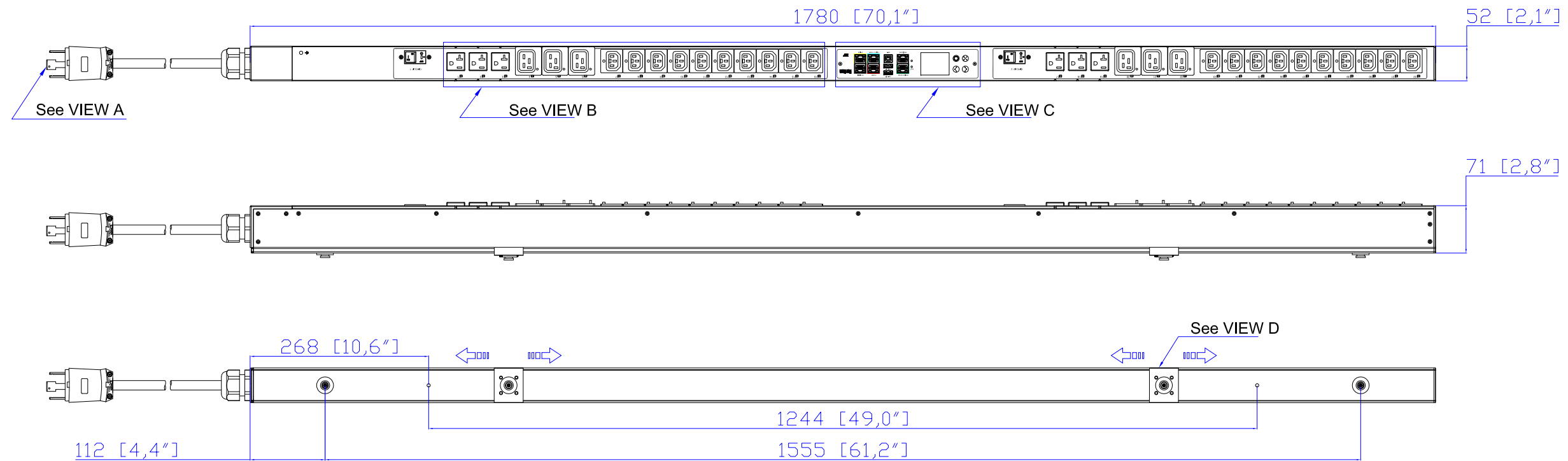
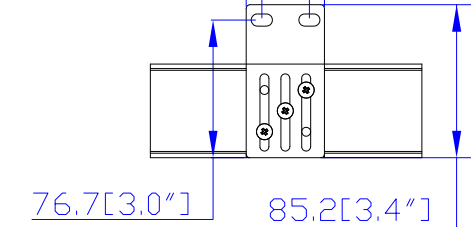
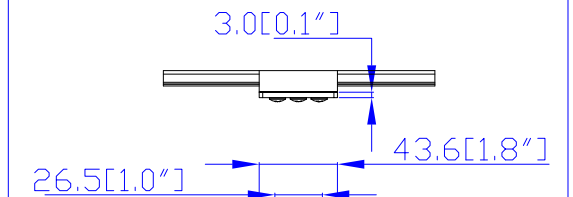

- NOTES:
1. INSTALLATION SHALL COMPLY WITH ALL APPLICABLE NATIONAL, STATE AND LOCAL CODES.
  2. PLEASE REFER TO PRODUCT DOCUMENTATION FOR FURTHER INFORMATION.
  3. UNLESS OTHERWISE SPECIFIED, ALL DIMENSIONS ARE IN MILLIMETERS [INCHES].
  4. MOUNTING BUTTON IS AN ALTERNATIVE MOUNTING METHOD TO THE TOOLLESS MOUNT FOR 3RD PARTY ENCLOSURE. BUTTON IS PROVIDED WITH THE UNIT. DETAILED INSTALLATION INSTRUCTIONS CAN BE FOUND IN THE PROVIDED MANUAL.
  5. BRACKET KITS TO MOUNT TO SPECIFIC 3RD PARTY ENCLOSURES ARE AVAILABLE AS OPTIONS.
  6. LENGTH OF THE CORD IS 3000MM +/- 70MM
  7. DIMENSION TOLERANCE: LENGTH +/- 3MM, WIDTH +/- 1MM, DEPTH +/- 0.5MM
  8. REFER TO THE TABLE FOR DETAIL CORD LENGTH DEFINITION

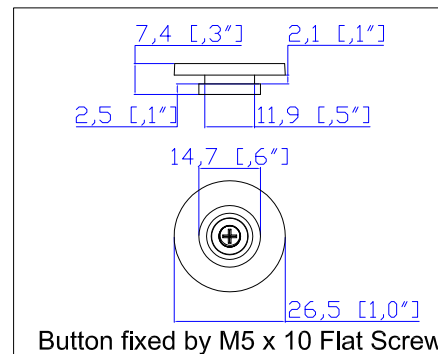

**Raritan**  
A brand of **Legrand**

Drawing Maker:	Eva Lin	June 07, 2017
Design Engineer:	Siang_H	June 07, 2017
Approver:	Tom_H	June 07, 2017

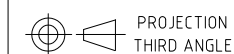

DO NOT SCALE DRAWING  
**SHEET 1 OF 1**

THIS DRAWING AND SPECIFICATIONS HEREIN ARE THE PROPERTY OF RARITAN, Inc. AND SHALL NOT BE COPIED, REPRODUCED OR USED, IN WHOLE OR IN PART, AS THE BASIS FOR THE MANUFACTURE OR SALE OF ITEMS WITHOUT WRITTEN PERMISSION FROM RARITAN, Inc. THIS DRAWING IS BASED UPON LATEST AVAILABLE INFORMATION AND IS SUBJECT TO CHANGE WITHOUT NOTICE.

TITLE: iPDU Zero U  
Single Phase, 24A/190-208V  
Plug Type: NEMA L14-30P  
Outlet Type: 110-120V: 5-20R (6)  
190-208V: Locking C19 (6), Locking C13 (20)

DWG NO. MPX3-4039U-E2P1 M5 & MPX3-5039U-E2P1 M5

MODEL NO. PX3-4039U-E2P1 & PX3-5039U-E2P1  
PX3-4039U-E2P1M5 & PX3-5039U-E2P1M5  
REV. **2A**