

NEMA L6-30P

VIEW A

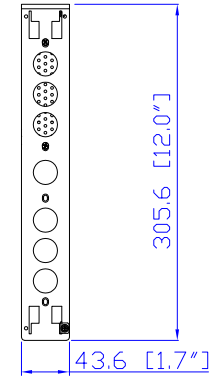
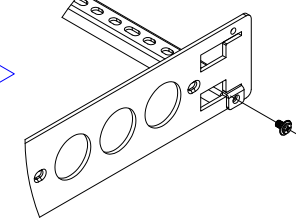
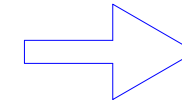
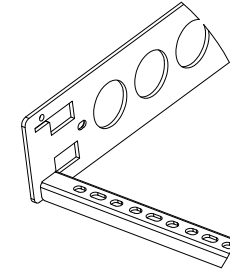
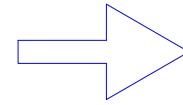
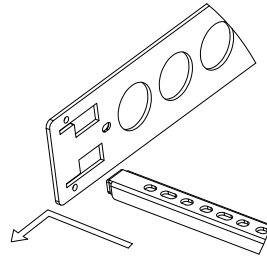
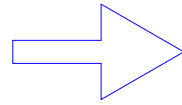
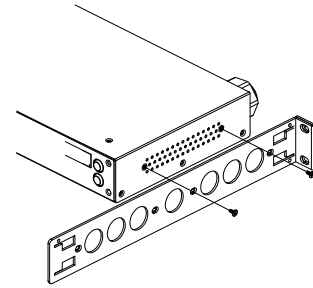

VIEW B

Rear

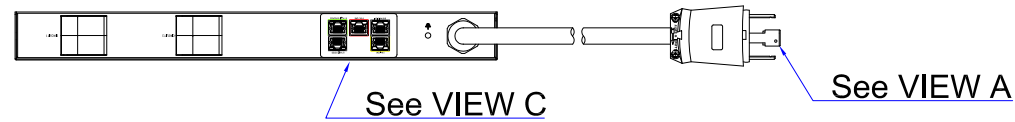

See VIEW C

See VIEW A

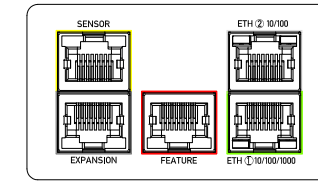

VIEW C

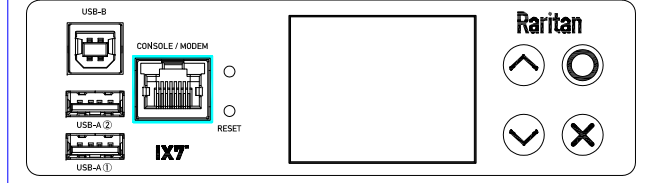

VIEW D

TOP

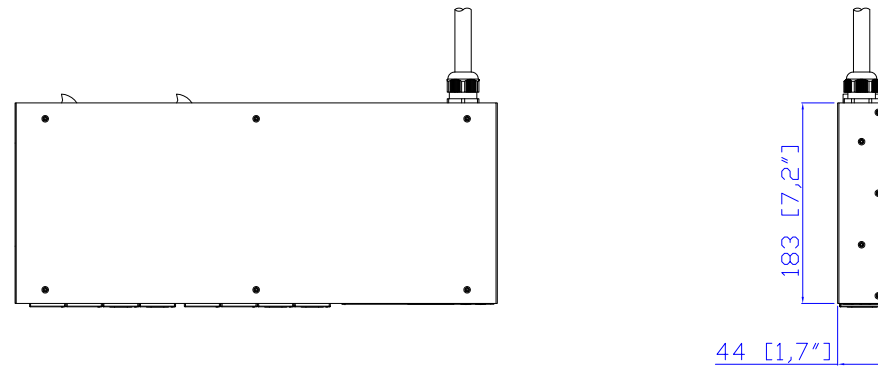

44 [1.7"]

Front

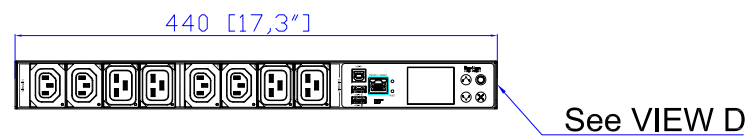

440 [17.3"]

See VIEW D

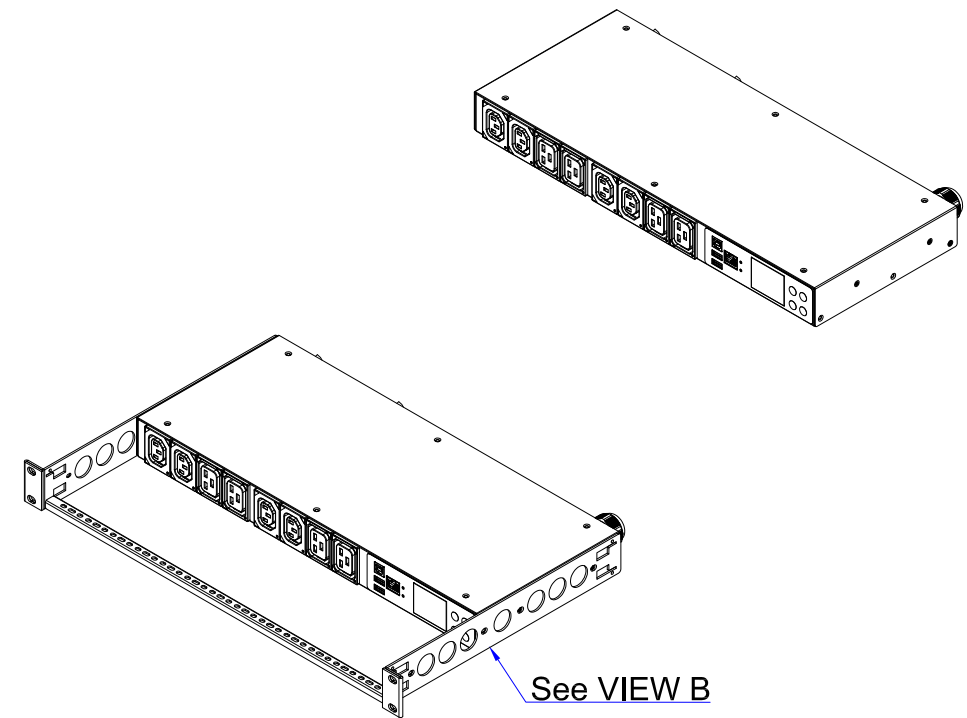

See VIEW B

NOTES:

1. INSTALLATION SHALL COMPLY WITH ALL APPLICABLE NATIONAL, STATE AND LOCAL CODES.
2. PLEASE REFER TO PRODUCT DOCUMENTATION FOR FURTHER INFORMATION.
3. UNLESS OTHERWISE SPECIFIED, ALL DIMENSIONS ARE IN MILLIMETERS (INCHES).
4. MOUNTING BUTTON IS AN ALTERNATIVE MOUNTING METHOD TO THE TOOLLESS MOUNT FOR 3RD PARTY ENCLOSURE. BUTTON IS PROVIDED WITH THE UNIT. DETAILED INSTALLATION INSTRUCTIONS CAN BE FOUND IN THE PROVIDED MANUAL.
5. BRACKET KITS TO MOUNT TO SPECIFIC 3RD PARTY ENCLOSURES ARE AVAILABLE AS OPTIONS.
6. LENGTH OF THE CORD IS 3000MM +/- 70MM
7. DIMENSION TOLERANCE: LENGTH +/- 3MM, WIDTH +/- 1MM, DEPTH +/- 0.5MM

Raritan
A brand of **Legrand**



PROJECTION
THIRD ANGLE

DO NOT SCALE DRAWING

SHEET 1 OF 1

THIS DRAWING AND SPECIFICATIONS HEREIN ARE THE PROPERTY OF RARITAN, Inc. AND SHALL NOT BE COPIED, REPRODUCED OR USED, IN WHOLE OR IN PART, AS THE BASIS FOR THE MANUFACTURE OR SALE OF ITEMS WITHOUT WRITTEN PERMISSION FROM RARITAN, Inc. THIS DRAWING IS BASED UPON LATEST AVAILABLE INFORMATION AND IS SUBJECT TO CHANGE WITHOUT NOTICE.

TITLE: iPDU One U
Single Phase, 24A/200-240V
Plug Type: NEMA L6-30P
Outlet Type: C13 (4), C19 (4)

DWG NO. MPX3-4198R-F1 M5 & MPX3-5198R-F1 M5

MODEL NO. **PX3-4198R-F1 & PX3-5198R-F1**
PX3-4198R-F1M5 & PX3-5198R-F1M5

REV. **2A**

Drawing Maker:	Eva Lin	Mar. 22, 2018
Design Engineer:	Siang_H	Mar. 22, 2018
Approver:	Tom_H	Mar. 22, 2018