

IEC60320 C20

VIEW A

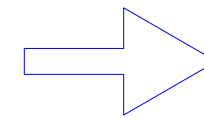

88.1 [3.5"]

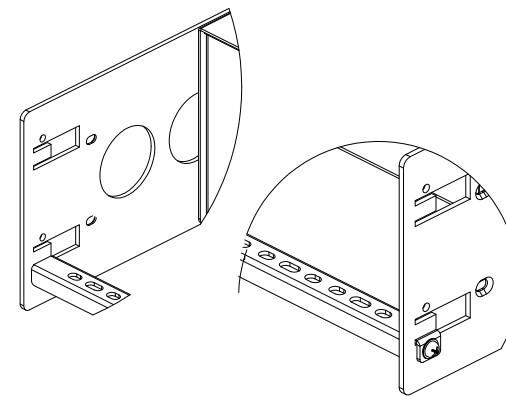
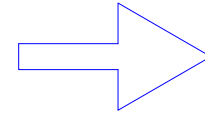
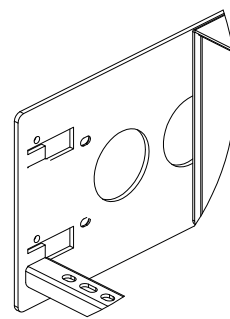
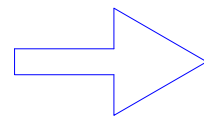
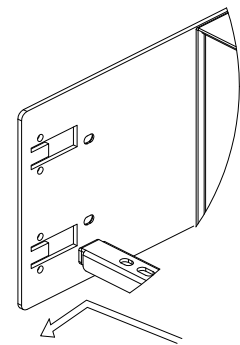
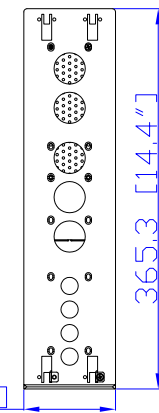

VIEW B

Rear

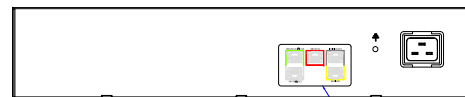

See VIEW C

IEC60320 C19 IEC60320 C20

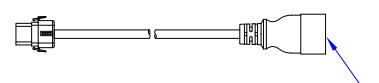

See VIEW A

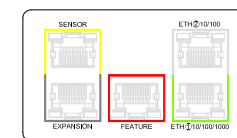

VIEW C

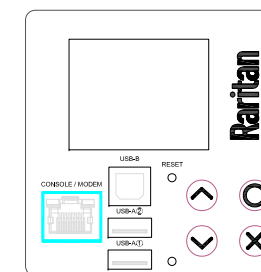

VIEW D

Top

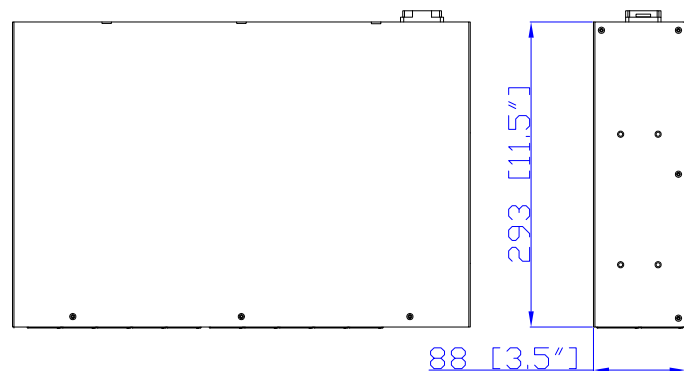

Front

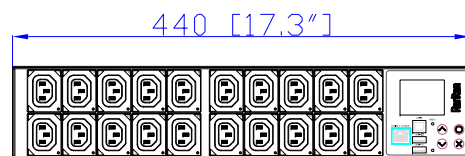

440 [17.3"]

See VIEW D

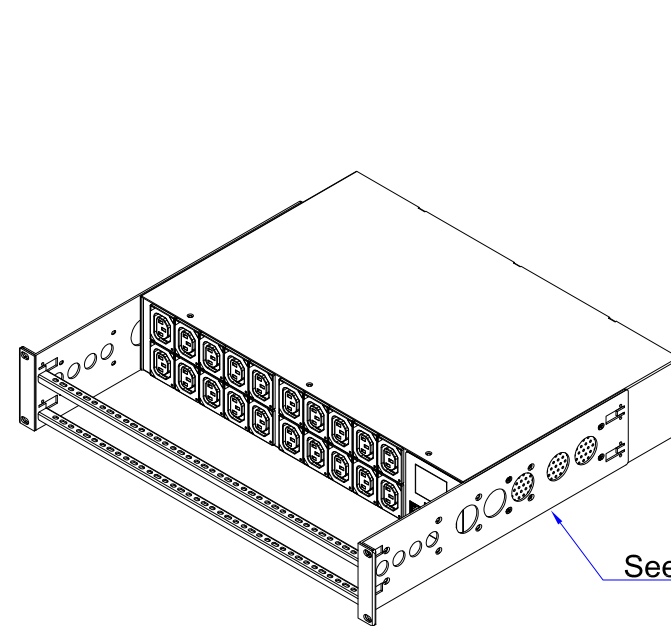

See VIEW B

- NOTES:
1. INSTALLATION SHALL COMPLY WITH ALL APPLICABLE NATIONAL, STATE AND LOCAL CODES.
  2. PLEASE REFER TO PRODUCT DOCUMENTATION FOR FURTHER INFORMATION.
  3. UNLESS OTHERWISE SPECIFIED, ALL DIMENSIONS ARE IN MILLIMETERS [INCHES].
  4. MOUNTING BUTTON IS AN ALTERNATIVE MOUNTING METHOD TO THE TOOLLESS MOUNT FOR 3RD PARTY ENCLOSURE. BUTTON IS PROVIDED WITH THE UNIT. DETAILED INSTALLATION INSTRUCTIONS CAN BE FOUND IN THE PROVIDED MANUAL.
  5. BRACKET KITS TO MOUNT TO SPECIFIC 3RD PARTY ENCLOSURES ARE AVAILABLE AS OPTIONS.
  6. LENGTH OF THE CORD IS 3000MM+/-70MM
  7. DIMENSION TOLERANCE: LENGTH +/-3MM, WIDTH +/-1MM, DEPTH +/-0.5MM

**Raritan**  
A brand of **Legrand**



PROJECTION  
THIRD ANGLE

DO NOT SCALE DRAWING

SHEET 1 OF 1

Drawing Maker:	Eva Lin	Sep. 05, 2016
Design Engineer:	Kenny_C	Sep. 05, 2016
Approver:	Tom_H	Sep. 05, 2016

THIS DRAWING AND SPECIFICATIONS HEREIN ARE THE PROPERTY OF RARITAN, INC. AND SHALL NOT BE COPIED, REPRODUCED OR USED, IN WHOLE OR IN PART, AS THE BASIS FOR THE MANUFACTURE OR SALE OF ITEMS WITHOUT WRITTEN PERMISSION FROM RARITAN, INC. THIS DRAWING IS BASED UPON LATEST AVAILABLE INFORMATION AND IS SUBJECT TO CHANGE WITHOUT NOTICE.

TITLE: iPDU Two U,  
Single phase, 16A/200V-240V  
Inlet Type: IEC60320 C20  
Plug Type: IEC60320 C20  
Outlet Type: (20)IEC320 C13

DWG NO. **MPX3-5434CR & MPX3-4434CR**

REV. **0A**