

IEC60320 C20

VIEW A

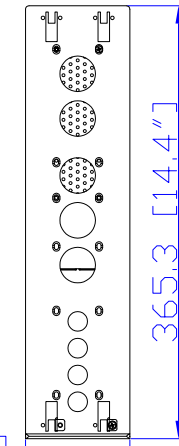
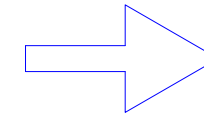
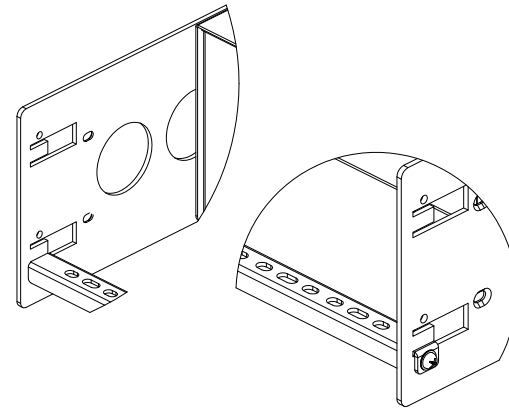
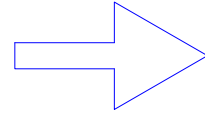
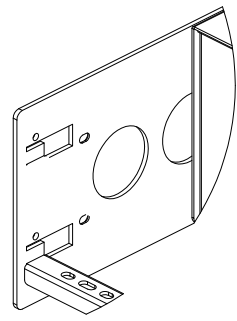
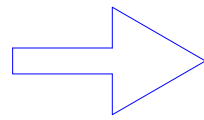
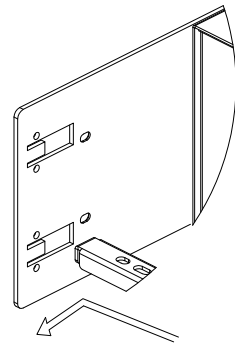

88.1 [3.5"]

365.3 [14.4"]

VIEW B

Rear



See VIEW C

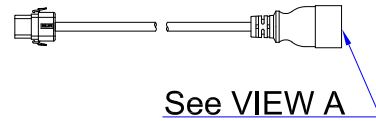

See VIEW A

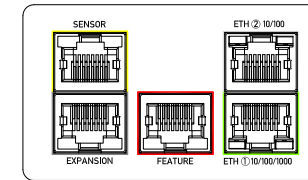

VIEW C (Rotated 180 degrees)

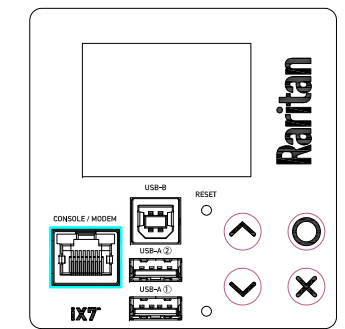

VIEW D

Top

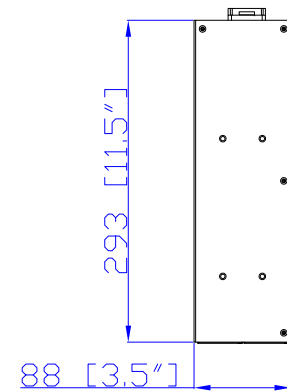
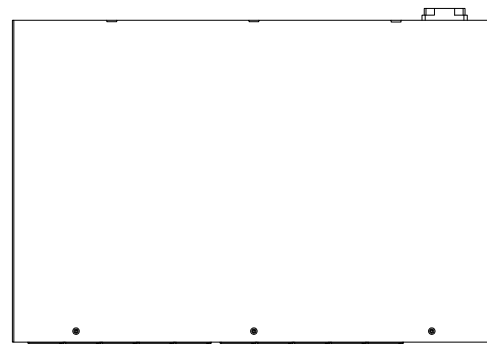

293 [11.5"]

88 [3.5"]

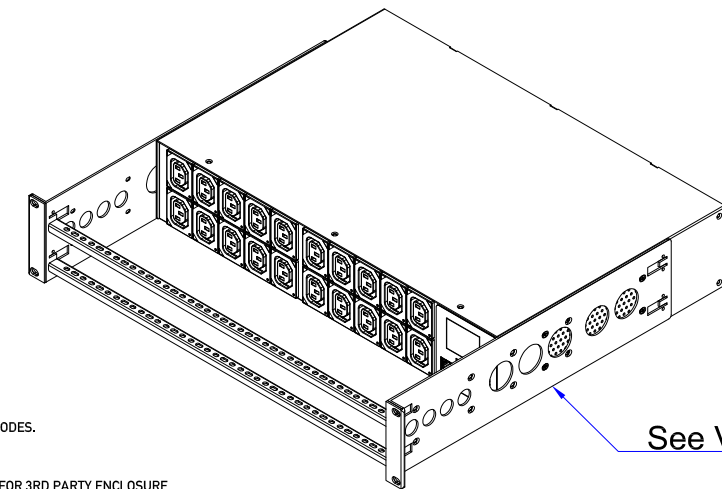
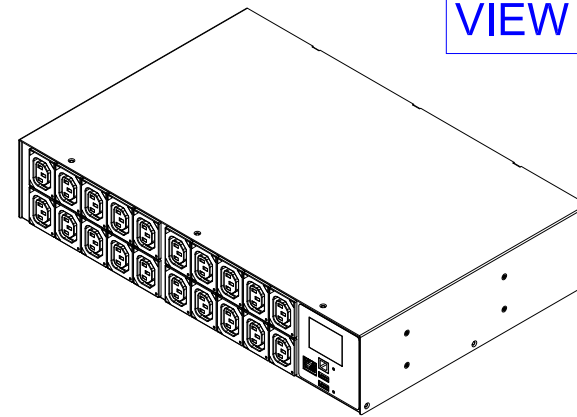

See VIEW B

Front

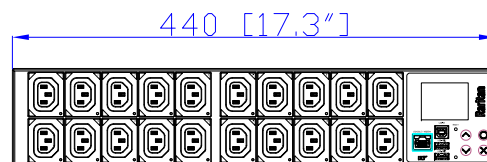

440 [17.3"]

See VIEW D

NOTES:

1. INSTALLATION SHALL COMPLY WITH ALL APPLICABLE NATIONAL, STATE AND LOCAL CODES.
2. PLEASE REFER TO PRODUCT DOCUMENTATION FOR FURTHER INFORMATION.
3. UNLESS OTHERWISE SPECIFIED, ALL DIMENSIONS ARE IN MILLIMETERS (INCHES).
4. MOUNTING BUTTON IS AN ALTERNATIVE MOUNTING METHOD TO THE TOOLLESS MOUNT FOR 3RD PARTY ENCLOSURE. BUTTON IS PROVIDED WITH THE UNIT. DETAILED INSTALLATION INSTRUCTIONS CAN BE FOUND IN THE PROVIDED MANUAL.
5. BRACKET KITS TO MOUNT TO SPECIFIC 3RD PARTY ENCLOSURES ARE AVAILABLE AS OPTIONS.
6. RARITAN STANDARD LENGTH OF THE CORD IS 3000MM +/- 70MM
7. DIMENSION TOLERANCE: LENGTH +/- 3MM, WIDTH +/- 1MM, DEPTH +/- 0.5MM

Raritan
A brand of **Legrand**

PROJECTION
THIRD ANGLE

DO NOT SCALE DRAWING
SHEET 1 OF 1

THIS DRAWING AND SPECIFICATIONS HEREIN ARE THE PROPERTY OF RARITAN, Inc. AND SHALL NOT BE COPIED, REPRODUCED OR USED, IN WHOLE OR IN PART, AS THE BASIS FOR THE MANUFACTURE OR SALE OF ITEMS WITHOUT WRITTEN PERMISSION FROM RARITAN, Inc. THIS DRAWING IS BASED UPON LATEST AVAILABLE INFORMATION AND IS SUBJECT TO CHANGE WITHOUT NOTICE.

Drawing Maker: Eva Lin

AUG. 04, 2020

Approver: Tom_H

AUG. 04, 2020

SPECIFICATION
iPDU Two U
200-240V, 16A
Inlet Type: IEC60320 C20
Plug Type: IEC60320 C20
Outlet Type: C13 (20)

DWG NO. MPX3-5440CR & MPX3-4440CR

MODEL NO. **PX3-5440CR & PX3-4440CR**

REV. **2A**