

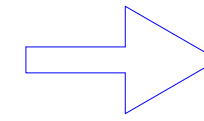

NEMA L6-30P

VIEW A

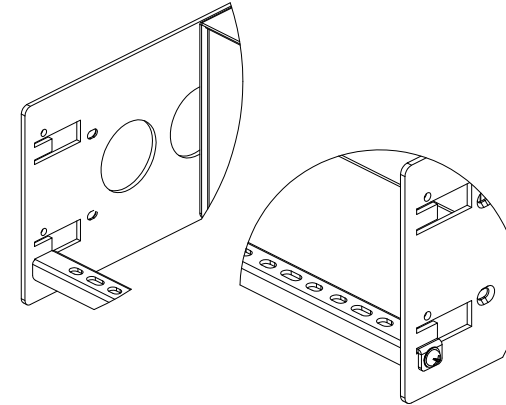
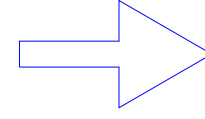
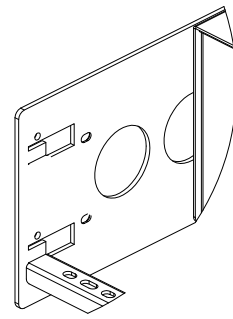
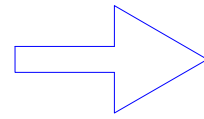
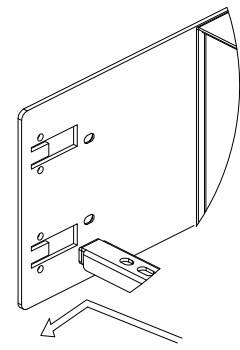

88.1 [3.5"]

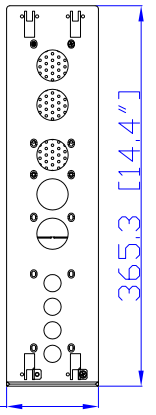

VIEW B

Rear



See VIEW C

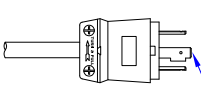

See VIEW A

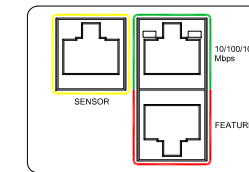

VIEW C

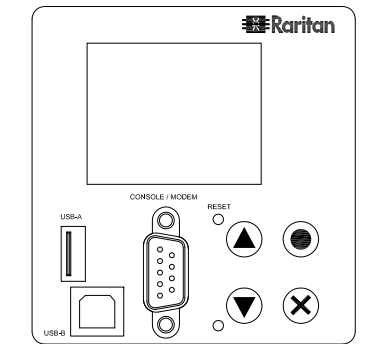

VIEW D

Top

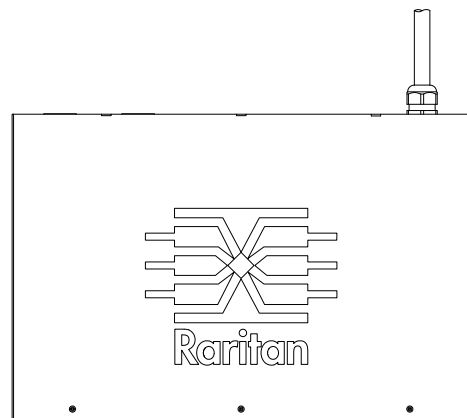

293 [11.5"]
88 [3.5"]

Front

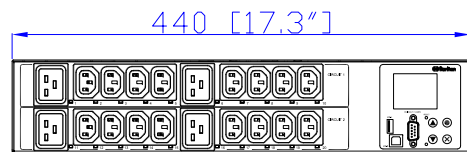

440 [17.3"]

See VIEW D

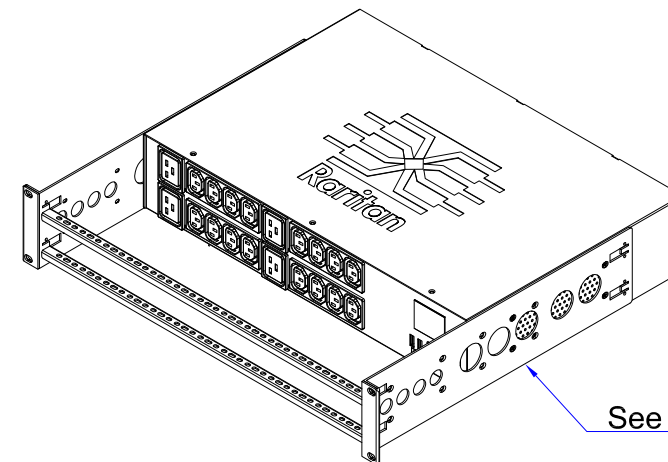

See VIEW B

NOTES:
ALL DIMENSIONS ARE MILLIMETERS[INCHES].

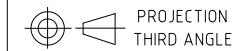

PROJECTION
THIRD ANGLE

DO NOT SCALE DRAWING

SHEET 1 OF 1

THIS DRAWING AND SPECIFICATIONS HEREIN ARE THE PROPERTY OF RARITAN, INC. AND SHALL NOT BE COPIED, REPRODUCED OR USED, IN WHOLE OR IN PART, AS THE BASIS FOR THE MANUFACTURE OR SALE OF ITEMS WITHOUT WRITTEN PERMISSION FROM RARITAN, INC. THIS DRAWING IS BASED UPON LATEST AVAILABLE INFORMATION AND IS SUBJECT TO CHANGE WITHOUT NOTICE.

TITLE:
iPDU Two U
Single phase, 24A/200V-240V
Plug Type: NEMA L6-30P
Outlet Type: (16)IEC320 C13, (4)IEC320 C19

DWG NO. **MPX3-5464R-G1 & MPX3-4464R-G1**

REV. **0A**

Drawing Maker:	EVA LIN	Jul. 31, 2015
Design Engineer:	Kenny_C	Jul. 31, 2015
Approver:	Tom_H	Jul. 31, 2015