

NEMA L15-30P

VIEW A

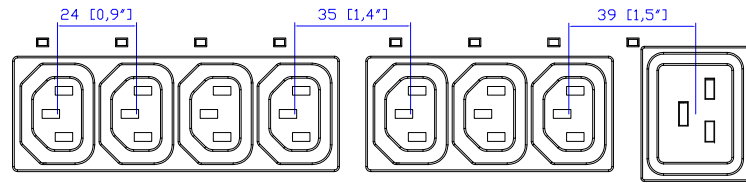

VIEW B

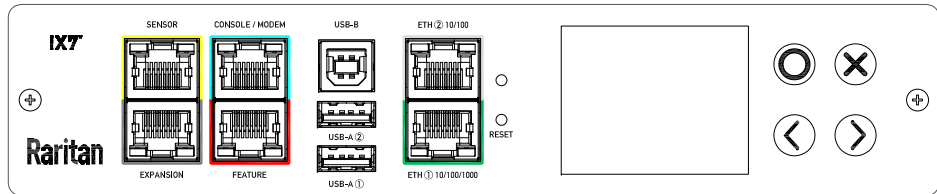

Option 1.

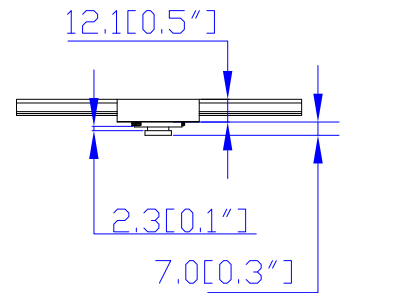

Option 2.

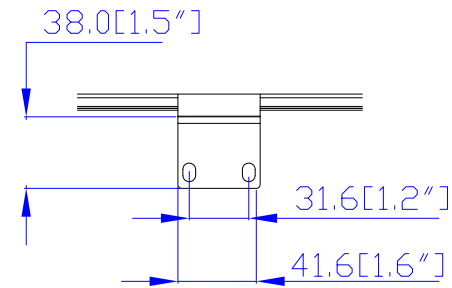

Option 3.

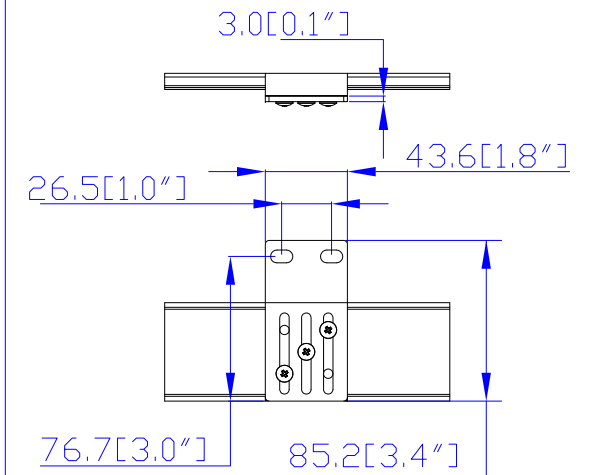

VIEW D

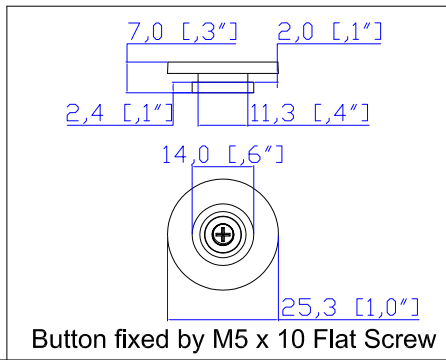
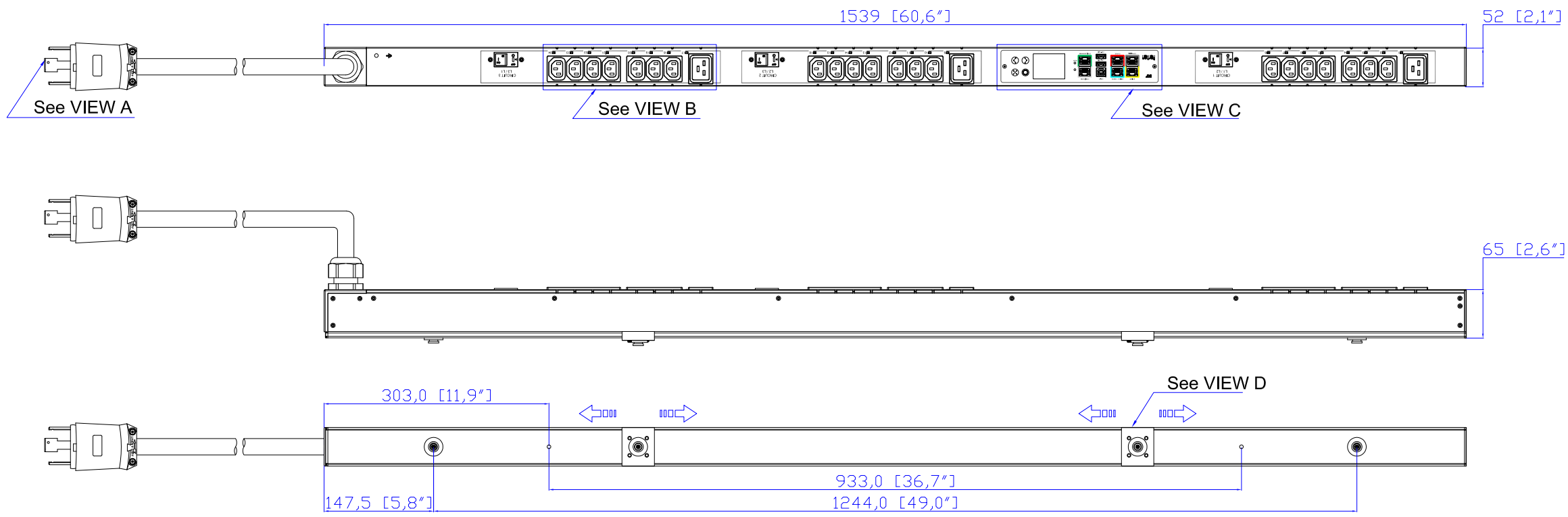

Button fixed by M5 x 10 Flat Screw

- NOTES:
1. INSTALLATION SHALL COMPLY WITH ALL APPLICABLE NATIONAL, STATE AND LOCAL CODES.
 2. PLEASE REFER TO PRODUCT DOCUMENTATION FOR FURTHER INFORMATION.
 3. UNLESS OTHERWISE SPECIFIED, ALL DIMENSIONS ARE IN MILLIMETERS [INCHES].
 4. MOUNTING BUTTON IS AN ALTERNATIVE MOUNTING METHOD TO THE TOOLLESS MOUNT FOR 3RD PARTY ENCLOSURE. BUTTON IS PROVIDED WITH THE UNIT. DETAILED INSTALLATION INSTRUCTIONS CAN BE FOUND IN THE PROVIDED MANUAL.
 5. BRACKET KITS TO MOUNT TO SPECIFIC 3RD PARTY ENCLOSURES ARE AVAILABLE AS OPTIONS.
 6. LENGTH OF THE CORD IS 3000MM +/- 70MM
 7. DIMENSION TOLERANCE: LENGTH +/- 3MM, WIDTH +/- 1MM, DEPTH +/- 0.5MM
 8. REFER TO THE TABLE FOR DETAIL CORD LENGTH DEFINITION

<p>A brand of </p>		PROJECTION THIRD ANGLE DO NOT SCALE DRAWING SHEET 1 OF 1	TITLE: iPDU Zero U Three Phase, 24A/208-240V Plug Type: NEMA L15-30P Outlet Type: C13 (21), C19 (3)	
			DWG NO.: MPX3-4523-N1 M5 & MPX3-5523-N1 M5 MODEL NO.: PX3-4523-N1 & PX3-5523-N1 PX3-4523-N1M5 & PX3-5523-N1M5	
Drawing Maker: EVA LIN Design Engineer: Kenny_C Approver: Tom_H	May 18, 2017 May 18, 2017 May 18, 2017	THIS DRAWING AND SPECIFICATIONS HEREIN ARE THE PROPERTY OF RARITAN, Inc. AND SHALL NOT BE COPIED, REPRODUCED OR USED, IN WHOLE OR IN PART, AS THE BASIS FOR THE MANUFACTURE OR SALE OF ITEMS WITHOUT WRITTEN PERMISSION FROM RARITAN, Inc. THIS DRAWING IS BASED UPON LATEST AVAILABLE INFORMATION AND IS SUBJECT TO CHANGE WITHOUT NOTICE.		
				REV. 2A