

IEC60309 32A 3PY

VIEW A

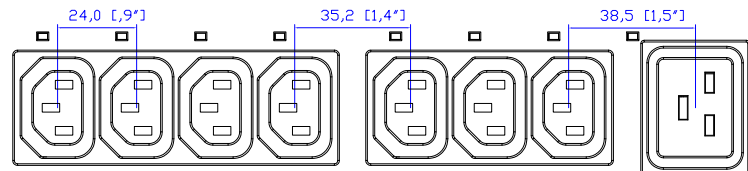

VIEW B

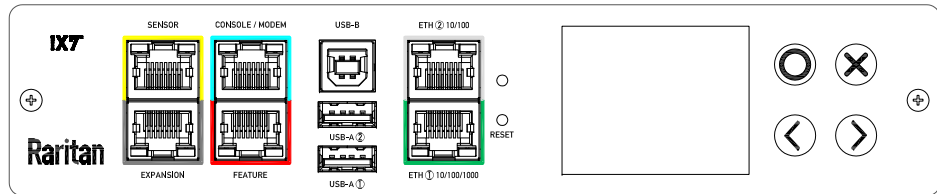

VIEW C

Option 1.

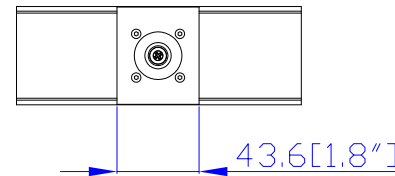
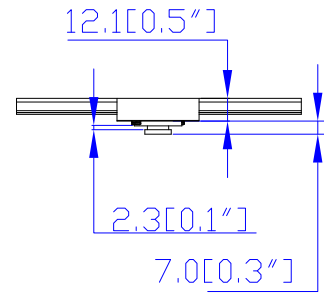

Option 2.

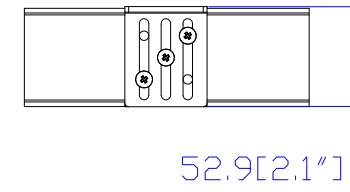
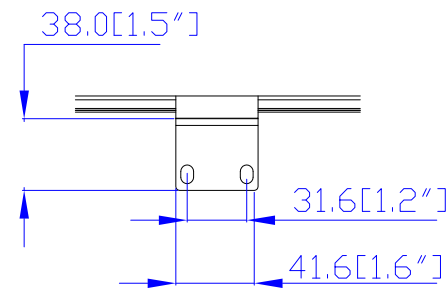

Option 3.

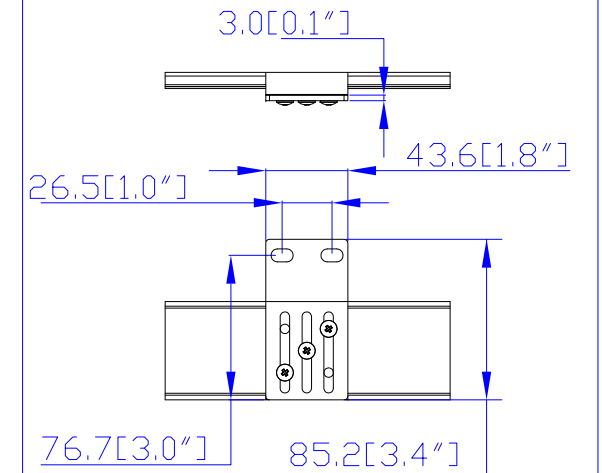

VIEW D

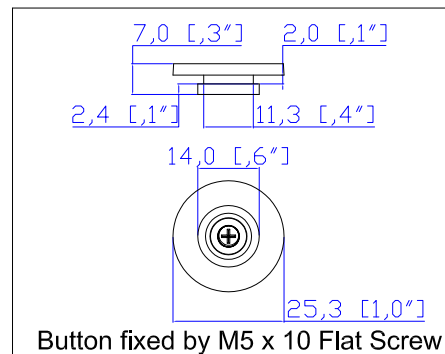
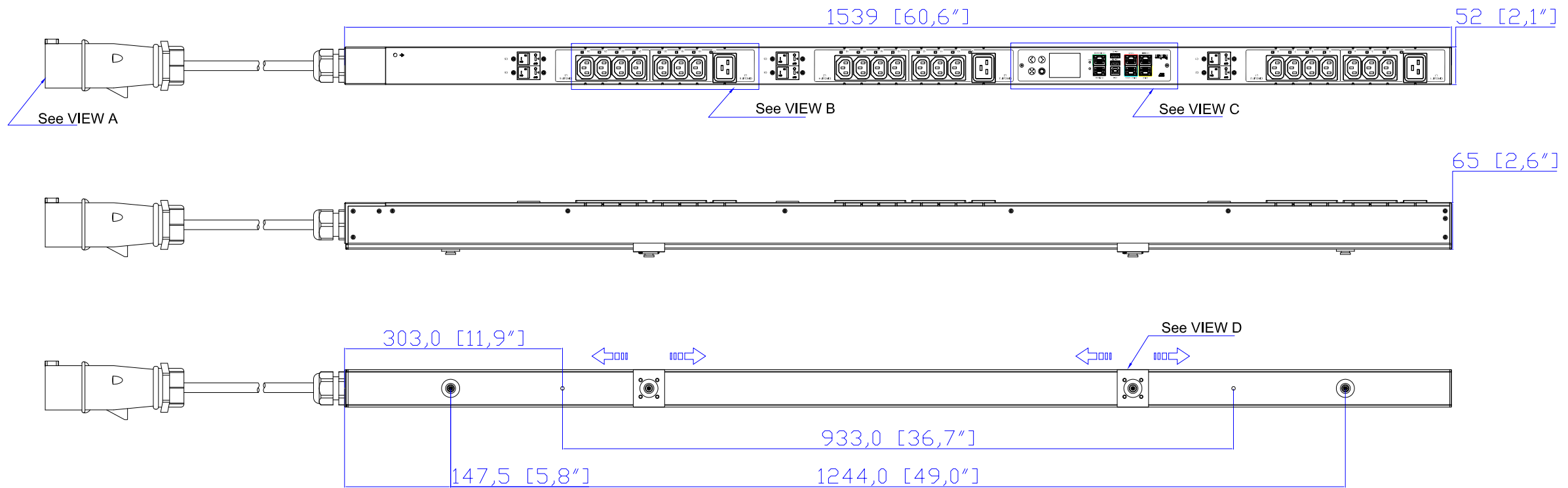

Button fixed by M5 x 10 Flat Screw

- NOTES:
1. INSTALLATION SHALL COMPLY WITH ALL APPLICABLE NATIONAL, STATE AND LOCAL CODES.
 2. PLEASE REFER TO PRODUCT DOCUMENTATION FOR FURTHER INFORMATION.
 3. UNLESS OTHERWISE SPECIFIED, ALL DIMENSIONS ARE IN MILLIMETERS (INCHES).
 4. MOUNTING BUTTON IS AN ALTERNATIVE MOUNTING METHOD TO THE TOOLLESS MOUNT FOR 3RD PARTY ENCLOSURE. BUTTON IS PROVIDED WITH THE UNIT. DETAILED INSTALLATION INSTRUCTIONS CAN BE FOUND IN THE PROVIDED MANUAL.
 5. BRACKET KITS TO MOUNT TO SPECIFIC 3RD PARTY ENCLOSURES ARE AVAILABLE AS OPTIONS.
 6. LENGTH OF THE CORD IS 3000MM +/- 70MM
 7. DIMENSION TOLERANCE: LENGTH +/- 3MM, WIDTH +/- 1MM, DEPTH +/- 0.5MM
 8. REFER TO THE TABLE FOR DETAIL CORD LENGTH DEFINITION

Raritan
A brand of **Legrand**



DO NOT SCALE DRAWING
SHEET 1 OF 1

THIS DRAWING AND SPECIFICATIONS HEREIN ARE THE PROPERTY OF RARITAN, Inc. AND SHALL NOT BE COPIED, REPRODUCED OR USED, IN WHOLE OR IN PART, AS THE BASIS FOR THE MANUFACTURE OR SALE OF ITEMS WITHOUT WRITTEN PERMISSION FROM RARITAN, Inc. THIS DRAWING IS BASED UPON LATEST AVAILABLE INFORMATION AND IS SUBJECT TO CHANGE WITHOUT NOTICE.

TITLE: iPDU Zero U
Three Phase, 32A/380-415V
Plug Type: IEC60309 32A 3PY
Outlet Type: C13 (21), C19 (3)

DWG NO: MPX3-4530V-N1 M5 & MPX3-5530V-N1 M5

MODEL NO: **PX3-4530V-N1 & PX3-5530V-N1**
PX3-4530V-N1M5 & PX3-5530V-N1M5

REV. **2A**

Drawing Maker: EVA LIN May 22, 2017
Design Engineer: Sam_L May 22, 2017
Approver: Tom_H May 22, 2017