

CS8365C
VIEW A

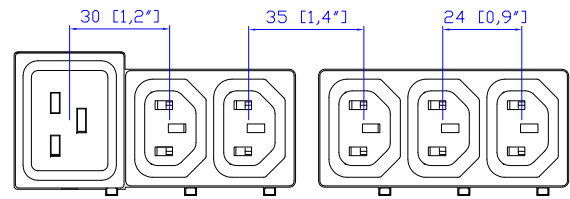

VIEW B

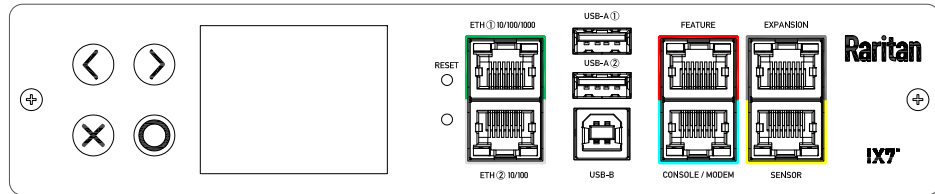

VIEW C

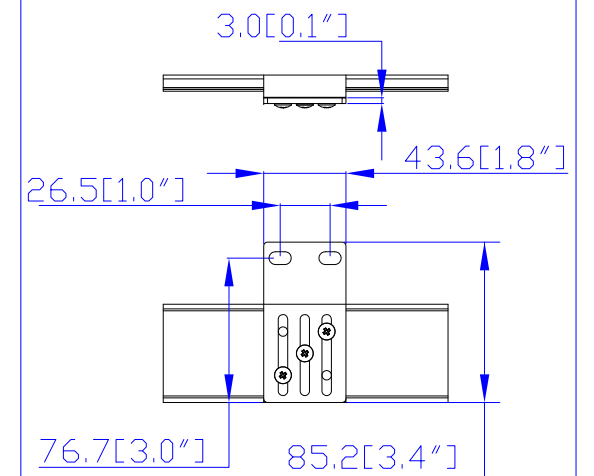
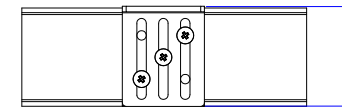
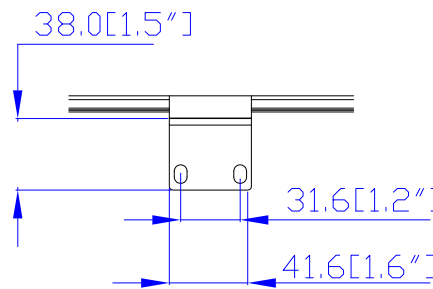
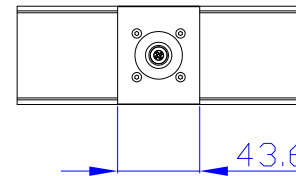
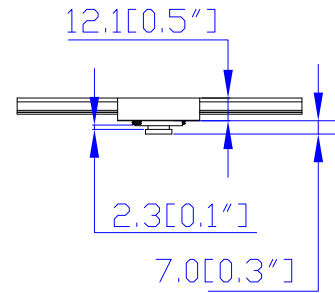

VIEW D

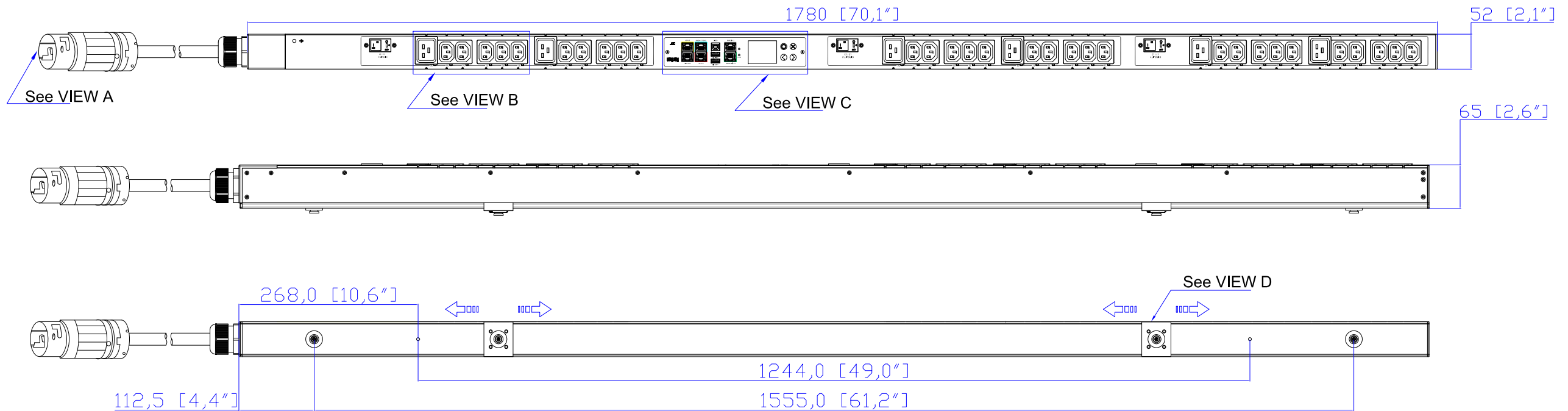

- NOTES:
1. INSTALLATION SHALL COMPLY WITH ALL APPLICABLE NATIONAL, STATE AND LOCAL CODES.
 2. PLEASE REFER TO PRODUCT DOCUMENTATION FOR FURTHER INFORMATION.
 3. UNLESS OTHERWISE SPECIFIED, ALL DIMENSIONS ARE IN MILLIMETERS (INCHES).
 4. MOUNTING BUTTON IS AN ALTERNATIVE MOUNTING METHOD TO THE TOOLLESS MOUNT FOR 3RD PARTY ENCLOSURE. BUTTON IS PROVIDED WITH THE UNIT. DETAILED INSTALLATION INSTRUCTIONS CAN BE FOUND IN THE PROVIDED MANUAL.
 5. BRACKET KITS TO MOUNT TO SPECIFIC 3RD PARTY ENCLOSURES ARE AVAILABLE AS OPTIONS.
 6. LENGTH OF THE CORD IS 3000MM +/- 70MM.
 7. DIMENSION TOLERANCE: LENGTH +/- 3MM, WIDTH +/- 1MM, DEPTH +/- 0.5MM.
 8. REFER TO THE TABLE FOR DETAIL CORD LENGTH DEFINITION.

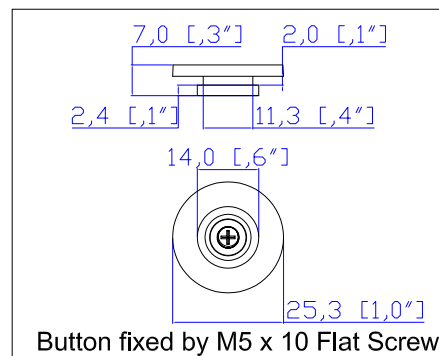

Raritan
A brand of **Legrand**

Drawing Maker: Eva Lin Nov. 30, 2017
 Design Engineer: Siang_H Nov. 30, 2017
 Approver: Tom_H Nov. 30, 2017

PROJECTION THIRD ANGLE
 DO NOT SCALE DRAWING
SHEET 1 OF 1

THIS DRAWING AND SPECIFICATIONS HEREIN ARE THE PROPERTY OF RARITAN, Inc. AND SHALL NOT BE COPIED, REPRODUCED OR USED, IN WHOLE OR IN PART, AS THE BASIS FOR THE MANUFACTURE OR SALE OF ITEMS WITHOUT WRITTEN PERMISSION FROM RARITAN, Inc. THIS DRAWING IS BASED UPON LATEST AVAILABLE INFORMATION AND IS SUBJECT TO CHANGE WITHOUT NOTICE.

TITLE: iPDU Zero U
 Three Phase, 35A/208-240V
 Plug Type: CS8365C
 Outlet Type: C13 (30), C19 (6)

DWG NO: MPX3-5719U M5 & MPX3-4719U M5

MODEL NO: **PX3-5719U & PX3-4719U**
PX3-5719U-M5 & PX3-4719U-M5
 REV. **2A**