

NEMA L6-20P

VIEW A

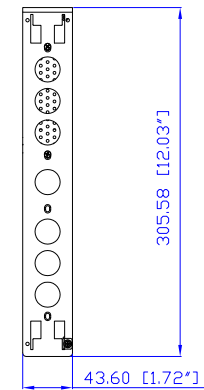
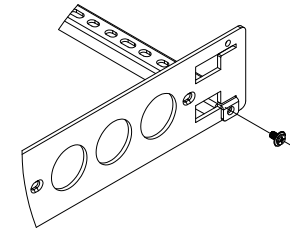
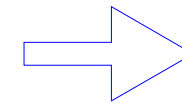
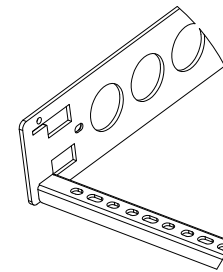
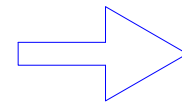
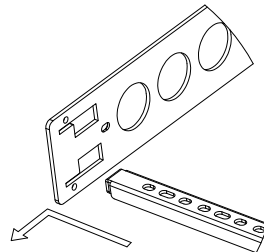
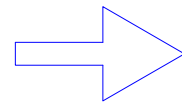
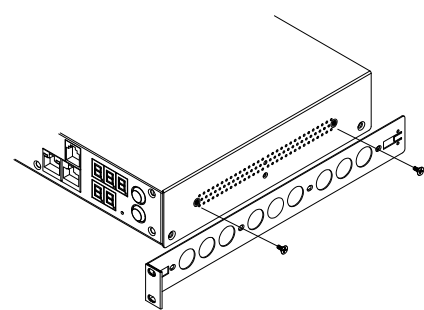

VIEW B

Rear



See VIEW C

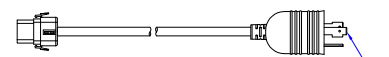

See VIEW A

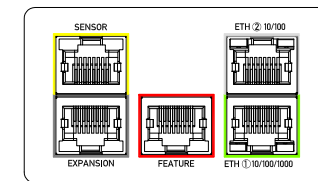

VIEW C

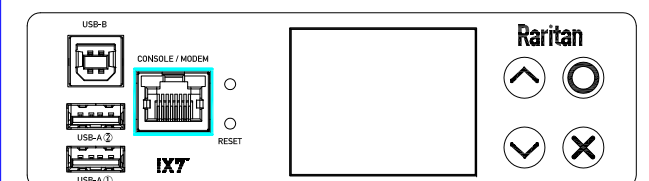

VIEW D

TOP

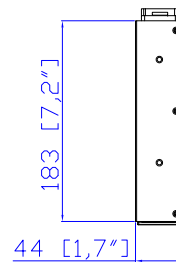
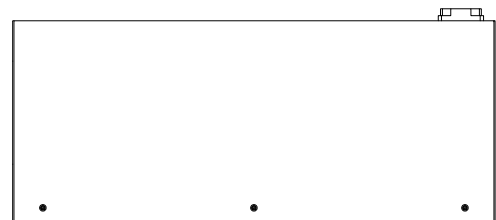

Front

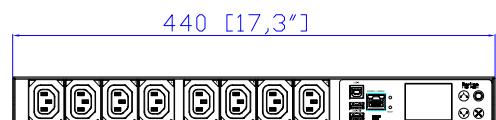

440 [17.3\"]

See VIEW D

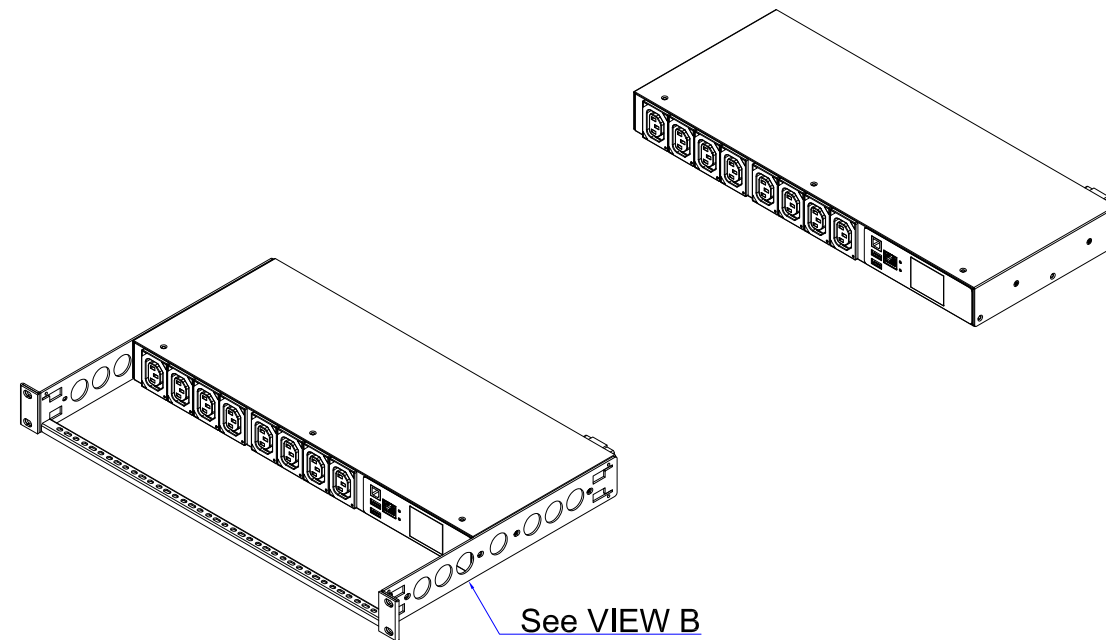

See VIEW B

- NOTES:
1. INSTALLATION SHALL COMPLY WITH ALL APPLICABLE NATIONAL, STATE AND LOCAL CODES.
 2. PLEASE REFER TO PRODUCT DOCUMENTATION FOR FURTHER INFORMATION.
 3. UNLESS OTHERWISE SPECIFIED, ALL DIMENSIONS ARE IN MILLIMETERS (INCHES).
 4. MOUNTING BUTTON IS AN ALTERNATIVE MOUNTING METHOD TO THE TOOLLESS MOUNT FOR 3RD PARTY ENCLOSURE. BUTTON IS PROVIDED WITH THE UNIT. DETAILED INSTALLATION INSTRUCTIONS CAN BE FOUND IN THE PROVIDED MANUAL.
 5. BRACKET KITS TO MOUNT TO SPECIFIC 3RD PARTY ENCLOSURES ARE AVAILABLE AS OPTIONS.
 6. LENGTH OF THE CORD IS 3000MM +/- 70MM.
 7. DIMENSION TOLERANCE: LENGTH +/- 3MM, WIDTH +/- 1MM, DEPTH +/- 0.5MM.

Raritan
A brand of **legrand**



PROJECTION
THIRD ANGLE

DO NOT SCALE DRAWING
SHEET 1 OF 1

THIS DRAWING AND SPECIFICATIONS HEREIN ARE THE PROPERTY OF RARITAN, Inc. AND SHALL NOT BE COPIED, REPRODUCED OR USED, IN WHOLE OR IN PART, AS THE BASIS FOR THE MANUFACTURE OR SALE OF ITEMS WITHOUT WRITTEN PERMISSION FROM RARITAN, Inc. THIS DRAWING IS BASED UPON LATEST AVAILABLE INFORMATION AND IS SUBJECT TO CHANGE WITHOUT NOTICE.

Drawing Maker: Eva Lin Feb. 25, 2019

Approver: Tom_H Feb. 25, 2019

TITLE: iPDU One U
Single Phase. 16A/200-240V
Inlet Type: IEC60320 C20
Plug Type: NEMA L6-20P
Outlet Type: C13 (8)

DWG NO. MPX3-5180R-F5 & MPX3-4180R-F5

MODEL NO. **PX3-5180R-F5 & PX3-4180R-F5**

REV. **2A**