

NEMA L6-30P

VIEW A

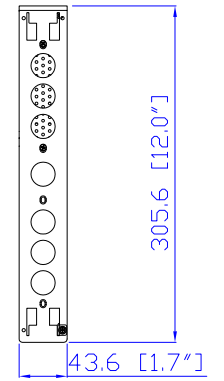
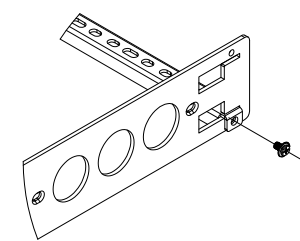
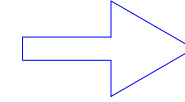
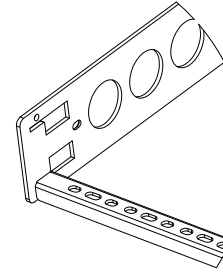
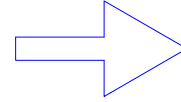
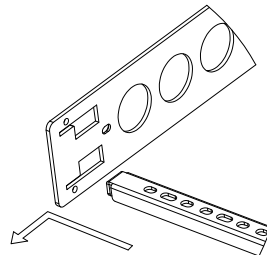
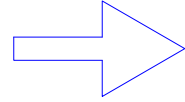
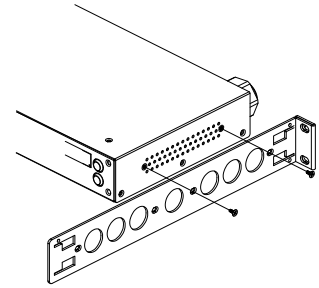

Mounting Bracket Installation Diagram

Rear



See VIEW B

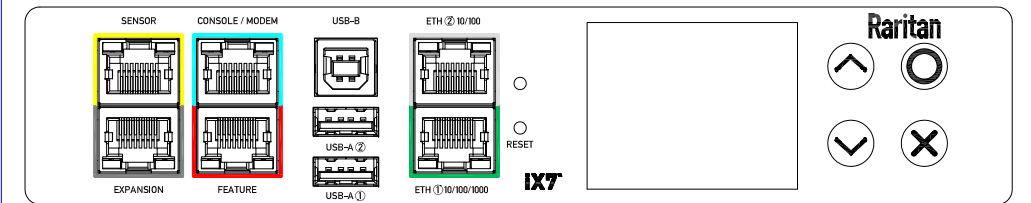

VIEW B

TOP

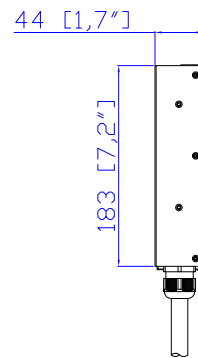
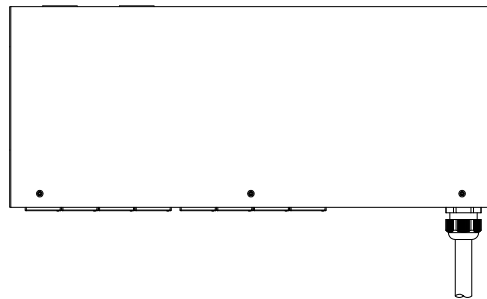

Front

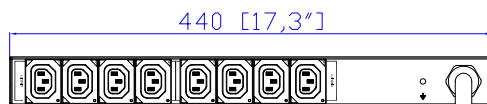

440 [17.3"]

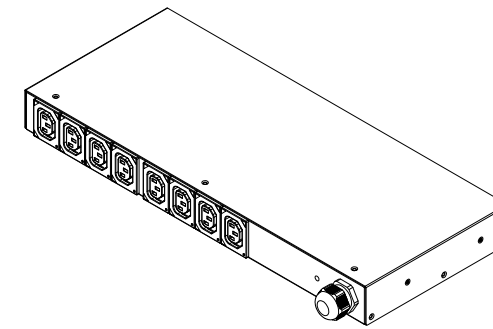
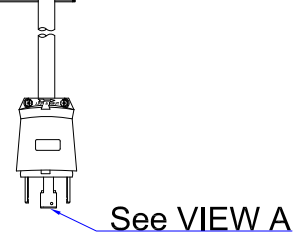

- NOTES:
1. INSTALLATION SHALL COMPLY WITH ALL APPLICABLE NATIONAL, STATE AND LOCAL CODES.
 2. PLEASE REFER TO PRODUCT DOCUMENTATION FOR FURTHER INFORMATION.
 3. UNLESS OTHERWISE SPECIFIED, ALL DIMENSIONS ARE IN MILLIMETERS (INCHES).
 4. MOUNTING BUTTON IS AN ALTERNATIVE MOUNTING METHOD TO THE TOOLLESS MOUNT FOR 3RD PARTY ENCLOSURE. BUTTON IS PROVIDED WITH THE UNIT. DETAILED INSTALLATION INSTRUCTIONS CAN BE FOUND IN THE PROVIDED MANUAL.
 5. BRACKET KITS TO MOUNT TO SPECIFIC 3RD PARTY ENCLOSURES ARE AVAILABLE AS OPTIONS.
 6. LENGTH OF THE CORD IS 3000MM +/- 70MM
 7. DIMENSION TOLERANCE: LENGTH +/- 3MM, WIDTH +/- 1MM, DEPTH +/- 0.5MM

Raritan
A brand of **legrand**



THIS DRAWING AND SPECIFICATIONS HEREIN ARE THE PROPERTY OF RARITAN, Inc. AND SHALL NOT BE COPIED, REPRODUCED OR USED, IN WHOLE OR IN PART, AS THE BASIS FOR THE MANUFACTURE OR SALE OF ITEMS WITHOUT WRITTEN PERMISSION FROM RARITAN, Inc. THIS DRAWING IS BASED UPON LATEST AVAILABLE INFORMATION AND IS SUBJECT TO CHANGE WITHOUT NOTICE.

DO NOT SCALE DRAWING
SHEET 1 OF 1

TITLE: **iPDU One U**
Single Phase, 24A/200-240V
Plug Type: NEMA L6-30P
Outlet Type: C13 (8)

DWG NO. MPX3-5200R-Q1 & MPX3-4200R-Q1

MODEL NO. **PX3-5200R-Q1 & PX3-4200R-Q1**

REV. **2A**

Drawing Maker:	Eva Lin	May 23, 2019
Design Engineer:	Sam_L	May 23, 2019
Approver:	Tom_H	May 23, 2019