

NEMA L6-30P

VIEW A

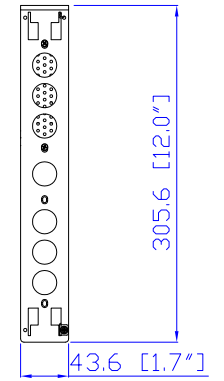

L Rack options

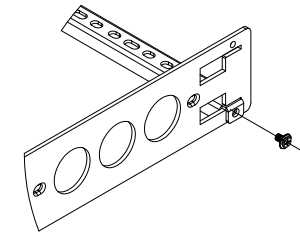
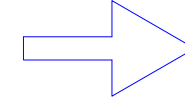
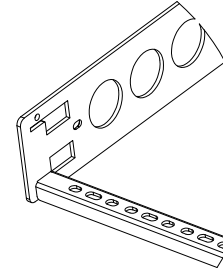
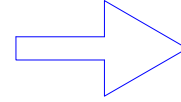
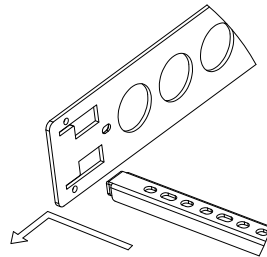
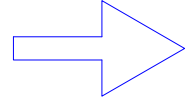
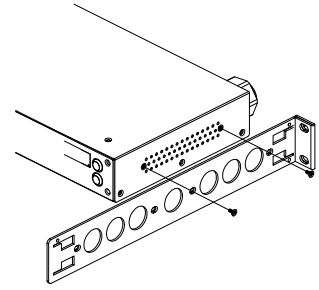
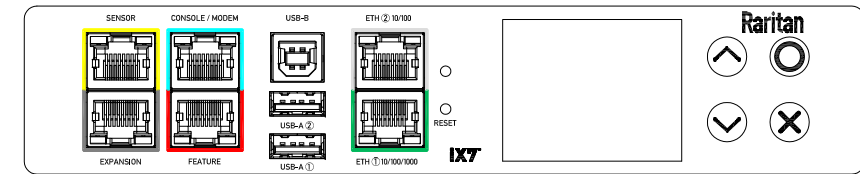

VIEW B

Rear



See VIEW A

See VIEW B

TOP

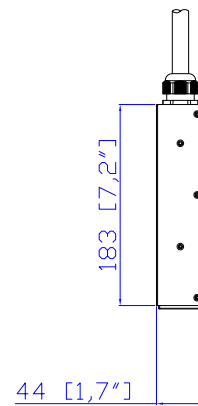
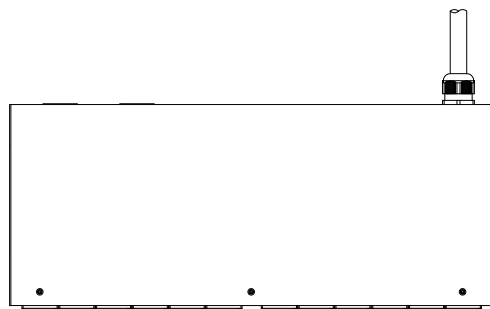

Front

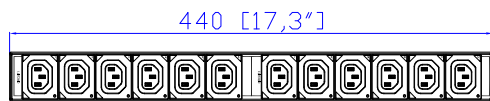

440 [17.3\"]

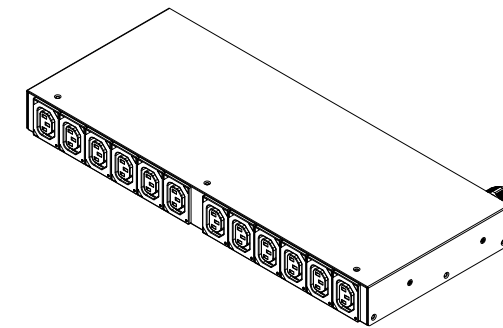

- NOTES:
1. INSTALLATION SHALL COMPLY WITH ALL APPLICABLE NATIONAL, STATE AND LOCAL CODES.
  2. PLEASE REFER TO PRODUCT DOCUMENTATION FOR FURTHER INFORMATION.
  3. UNLESS OTHERWISE SPECIFIED, ALL DIMENSIONS ARE IN MILLIMETERS (INCHES).
  4. MOUNTING BUTTON IS AN ALTERNATIVE MOUNTING METHOD TO THE TOOLLESS MOUNT FOR 3RD PARTY ENCLOSURE. BUTTON IS PROVIDED WITH THE UNIT. DETAILED INSTALLATION INSTRUCTIONS CAN BE FOUND IN THE PROVIDED MANUAL.
  5. BRACKET KITS TO MOUNT TO SPECIFIC 3RD PARTY ENCLOSURES ARE AVAILABLE AS OPTIONS.
  6. LENGTH OF THE CORD IS 3000MM +/- 70MM
  7. DIMENSION TOLERANCE: LENGTH +/- 3MM, WIDTH +/- 1MM, DEPTH +/- 0.5MM

**Raritan**  
A brand of **Legrand**



THIS DRAWING AND SPECIFICATIONS HEREIN ARE THE PROPERTY OF RARITAN, Inc. AND SHALL NOT BE COPIED, REPRODUCED OR USED, IN WHOLE OR IN PART, AS THE BASIS FOR THE MANUFACTURE OR SALE OF ITEMS WITHOUT WRITTEN PERMISSION FROM RARITAN, Inc. THIS DRAWING IS BASED UPON LATEST AVAILABLE INFORMATION AND IS SUBJECT TO CHANGE WITHOUT NOTICE.

DO NOT SCALE DRAWING  
**SHEET 1 OF 1**

TITLE: iPDU One U  
Single Phase, 24A/200-240V  
Plug Type: NEMA L6-30P  
Outlet Type: C13 (12)

DWG NO: MPX3-5284R M5 & MPX3-4284R M5

MODEL NO: **PX3-5284R & PX3-4284R**  
**PX3-5284R-M5 & PX3-4284R-M5**

REV.  
**2A**

Drawing Maker:	Eva Lin	Apr. 25, 2018
Design Engineer:	Sam_L	Apr. 25, 2018
Approver:	Tom_H	Apr. 25, 2018