

- $\phi 3.4$ $\phi 8.9$
 $\phi 5.3$
1. KST RNBS 5-5 or equivalent terminals for 10 AWG Wire
 2. Inside diameter 5.3 mm & Outside diameter 8.9 mm terminal ring for M5 screw

VIEW A

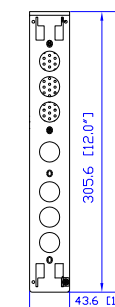
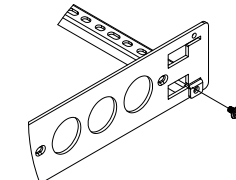
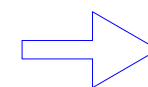
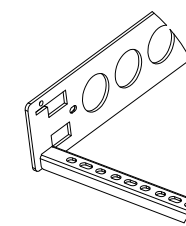
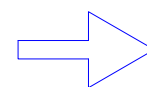
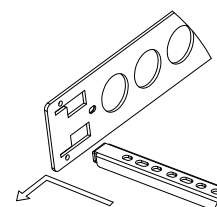
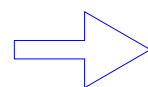
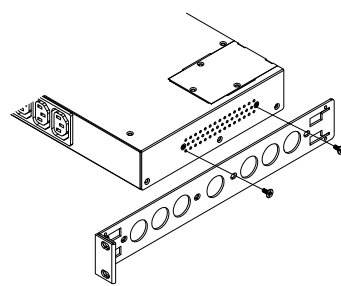

VIEW B

Rear

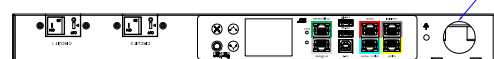

Knockout Size: 1.109" for 3/4 flexible steel conduit cable & fitting

See VIEW C

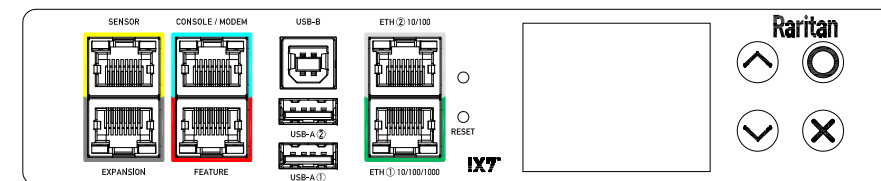

VIEW C

TOP

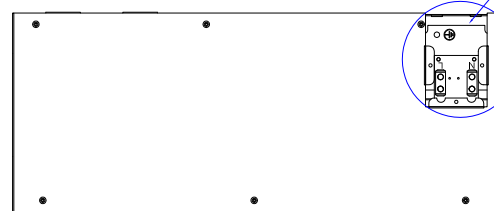

See VIEW A

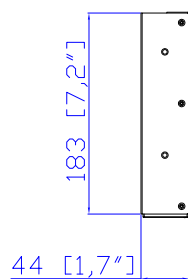

Front

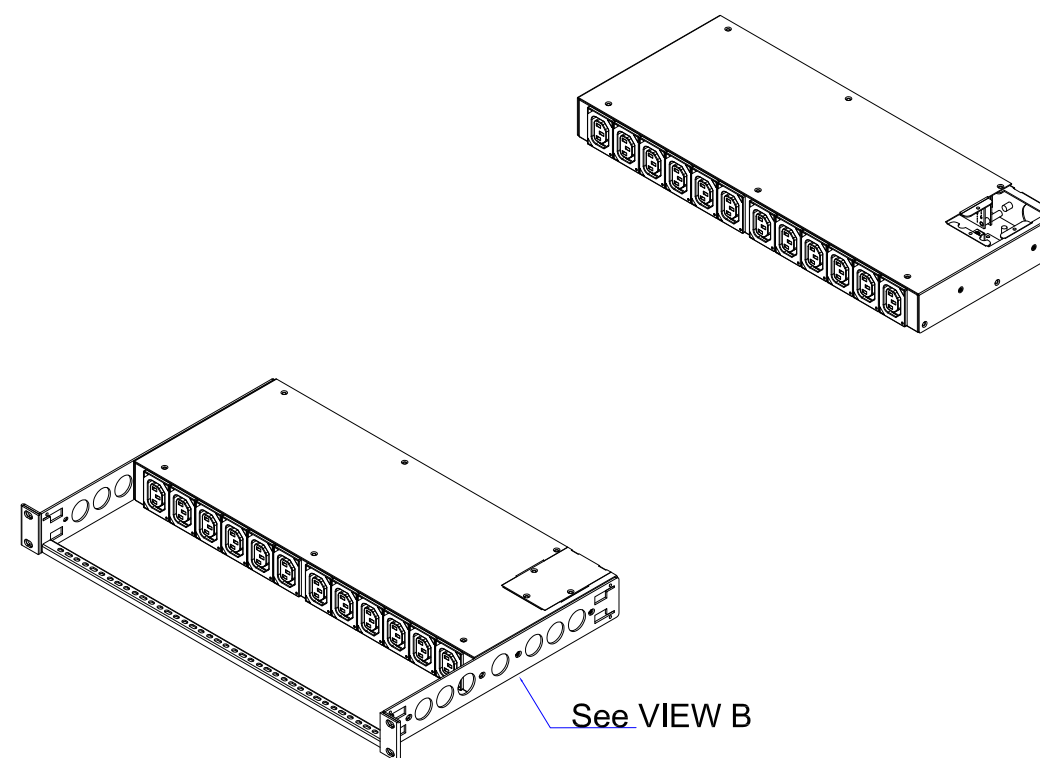
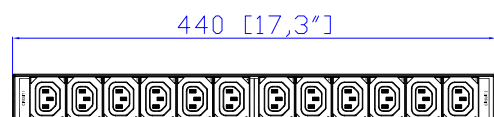

See VIEW B

- NOTES:
1. INSTALLATION SHALL COMPLY WITH ALL APPLICABLE NATIONAL, STATE AND LOCAL CODES.
 2. PLEASE REFER TO PRODUCT DOCUMENTATION FOR FURTHER INFORMATION.
 3. UNLESS OTHERWISE SPECIFIED, ALL DIMENSIONS ARE IN MILLIMETERS (INCHES).
 4. MOUNTING BUTTON IS AN ALTERNATIVE MOUNTING METHOD TO THE TOOLLESS MOUNT FOR 3RD PARTY ENCLOSURE. BUTTON IS PROVIDED WITH THE UNIT. DETAILED INSTALLATION INSTRUCTIONS CAN BE FOUND IN THE PROVIDED MANUAL.
 5. BRACKET KITS TO MOUNT TO SPECIFIC 3RD PARTY ENCLOSURES ARE AVAILABLE AS OPTIONS.
 6. LENGTH OF THE CORD IS 3000MM +/- 70MM
 7. DIMENSION TOLERANCE: LENGTH +/- 3MM, WIDTH +/- 1MM, DEPTH +/- 0.5MM
 8. REFER TO THE TABLE FOR DETAIL CORD LENGTH DEFINITION

Raritan
A brand of **legrand**



PROJECTION
THIRD ANGLE

DO NOT SCALE DRAWING

SHEET 1 OF 1

THIS DRAWING AND SPECIFICATIONS HEREIN ARE THE PROPERTY OF RARITAN, Inc. AND SHALL NOT BE COPIED, REPRODUCED OR USED, IN WHOLE OR IN PART, AS THE BASIS FOR THE MANUFACTURE OR SALE OF ITEMS WITHOUT WRITTEN PERMISSION FROM RARITAN, Inc. THIS DRAWING IS BASED UPON LATEST AVAILABLE INFORMATION AND IS SUBJECT TO CHANGE WITHOUT NOTICE.

Drawing Maker:	Eva Lin	Jul. 06 , 2017
Design Engineer:	Siang_H	Jul. 06 , 2017
Approver:	Tom_H	Jul. 06 , 2017

TITLE: iPDU One U
Single Phase, 32A/200-240V
Plug Type: 32A Terminal
Outlet Type: C13 (12)

DWG NO. MPX3-5292YR-F9 M5 & MPX3-4292YR-F9 M5

MODEL NO. PX3-5292YR-F9 & PX3-4292YR-F9
PX3-5292YR-F9M5 & PX3-4292YR-F9M5

REV. 2A