

IEC60309 16A

VIEW A

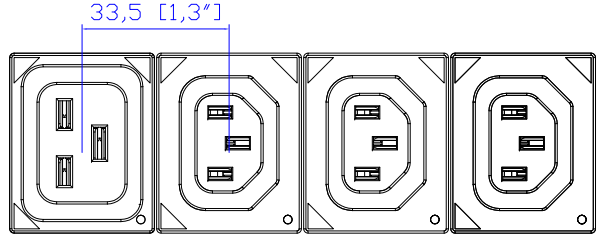

VIEW B

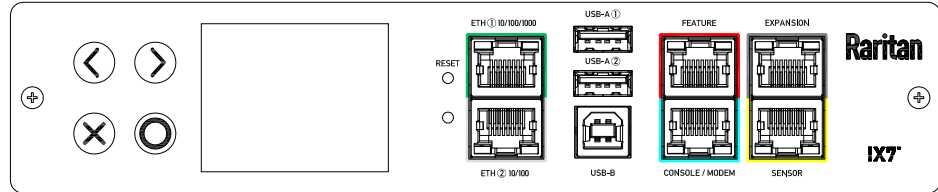

VIEW C

Option 1.

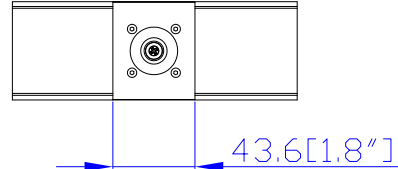
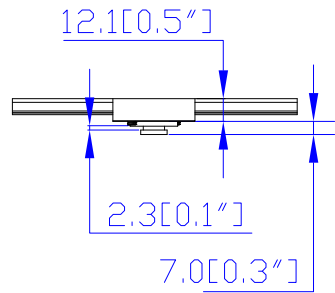

Option 2.

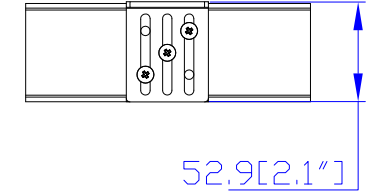
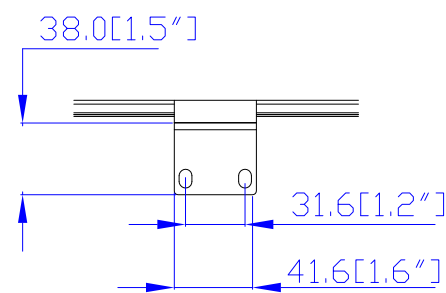

Option 3.

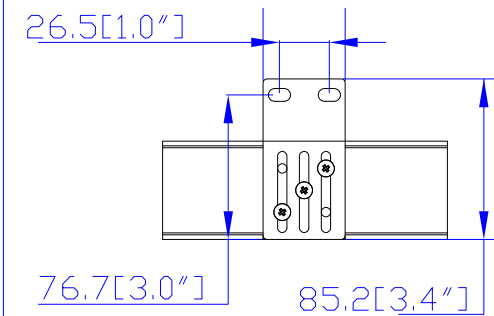
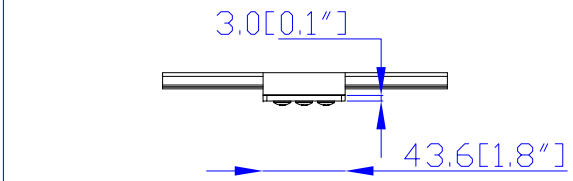

VIEW D

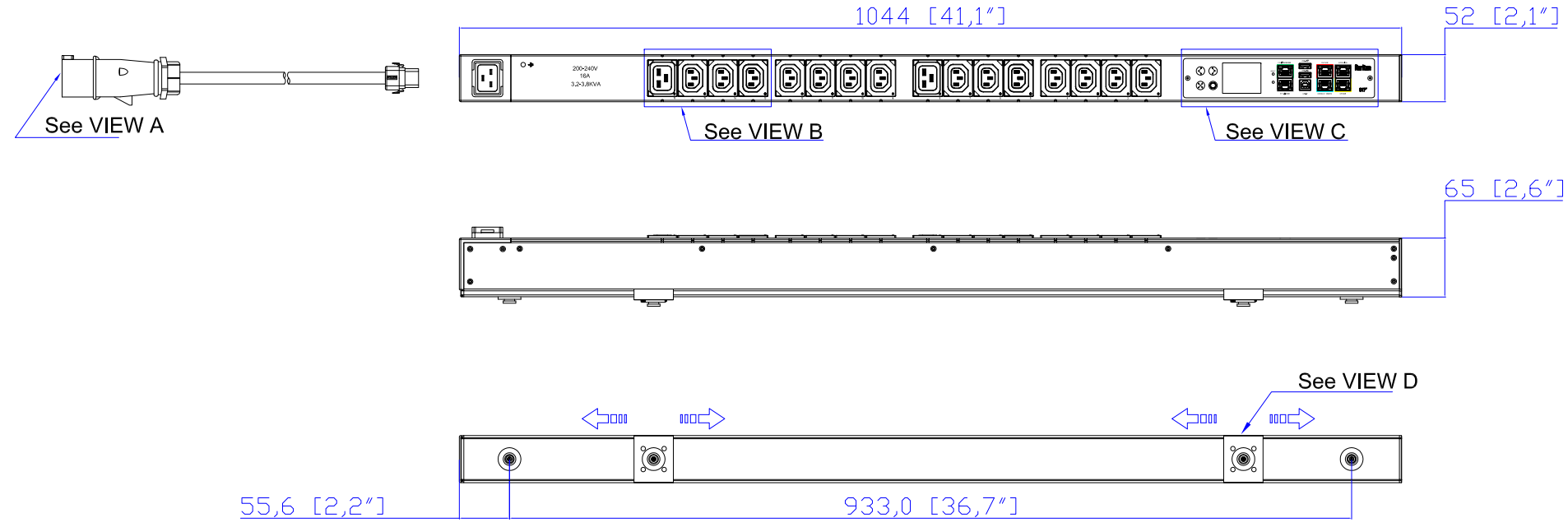

- NOTES:
1. INSTALLATION SHALL COMPLY WITH ALL APPLICABLE NATIONAL, STATE AND LOCAL CODES.
 2. PLEASE REFER TO PRODUCT DOCUMENTATION FOR FURTHER INFORMATION.
 3. UNLESS OTHERWISE SPECIFIED, ALL DIMENSIONS ARE IN MILLIMETERS [INCHES].
 4. MOUNTING BUTTON IS AN ALTERNATIVE MOUNTING METHOD TO THE TOOLLESS MOUNT FOR 3RD PARTY ENCLOSURE. BUTTON IS PROVIDED WITH THE UNIT. DETAILED INSTALLATION INSTRUCTIONS CAN BE FOUND IN THE PROVIDED MANUAL.
 5. BRACKET KITS TO MOUNT TO SPECIFIC 3RD PARTY ENCLOSURES ARE AVAILABLE AS OPTIONS.
 6. LENGTH OF THE CORD IS 3000MM +/- 70MM
 7. DIMENSION TOLERANCE: LENGTH +/- 3MM, WIDTH +/- 1MM, DEPTH +/- 0,5MM

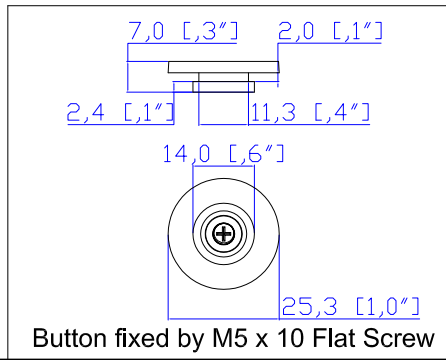

<p>A brand of legrand</p>	PROJECTION THIRD ANGLE	DO NOT SCALE DRAWING SHEET 1 OF 1	TITLE: iPDU Zero U Single Phase, 16A/200-240V Inlet Type: IEC60320 C20 Plug Type: IEC60309 16A Outlet Type: C13 (14), C19 (2)
	Drawing Maker: Eva Lin May 30 , 2018 Design Engineer: Kenny_C May 30 , 2018 Approver: Tom_H May 30 , 2018	THIS DRAWING AND SPECIFICATIONS HEREIN ARE THE PROPERTY OF RARITAN, Inc. AND SHALL NOT BE COPIED, REPRODUCED OR USED, IN WHOLE OR IN PART, AS THE BASIS FOR THE MANUFACTURE OR SALE OF ITEMS WITHOUT WRITTEN PERMISSION FROM RARITAN, Inc. THIS DRAWING IS BASED UPON LATEST AVAILABLE INFORMATION AND IS SUBJECT TO CHANGE WITHOUT NOTICE.	DWG NO: MPX3-5367 M5 & MPX3-4367 M5

REV.
2A