

NEMA L5-20P

VIEW A

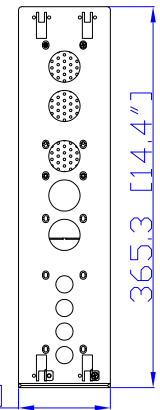

VIEW B

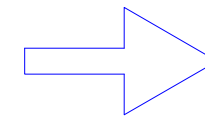
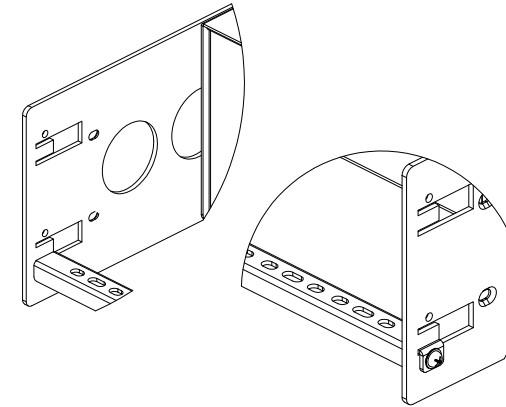
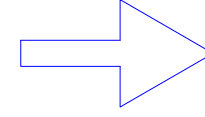
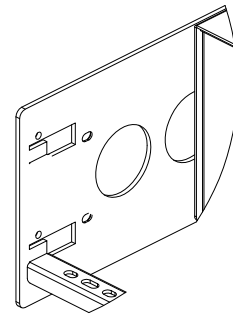
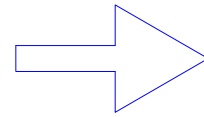
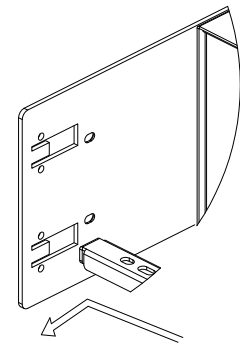
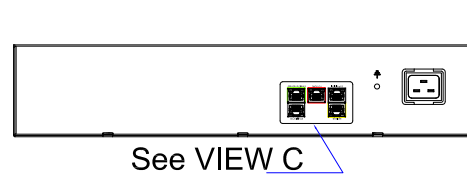

See VIEW C

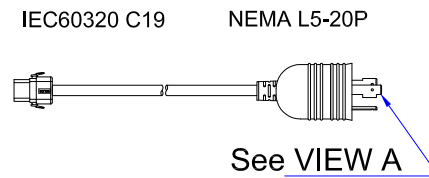

See VIEW A

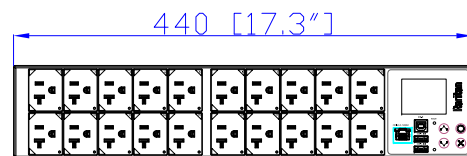
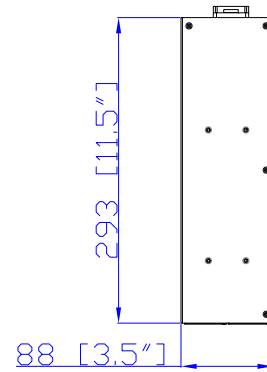
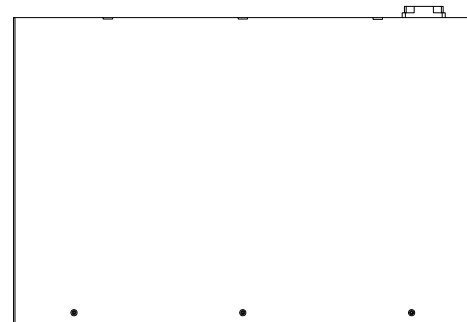

See VIEW D

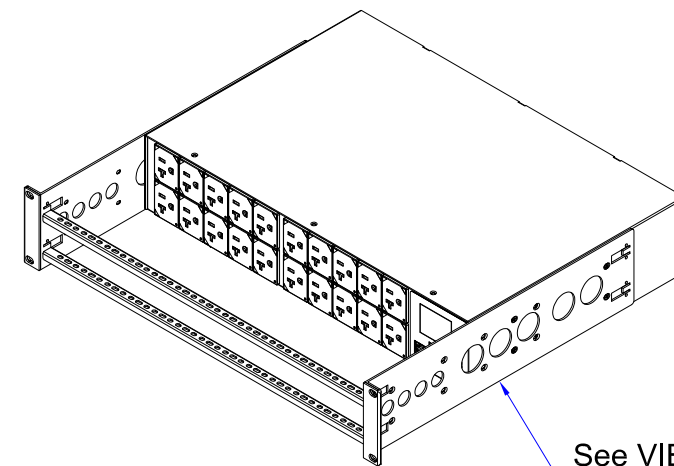
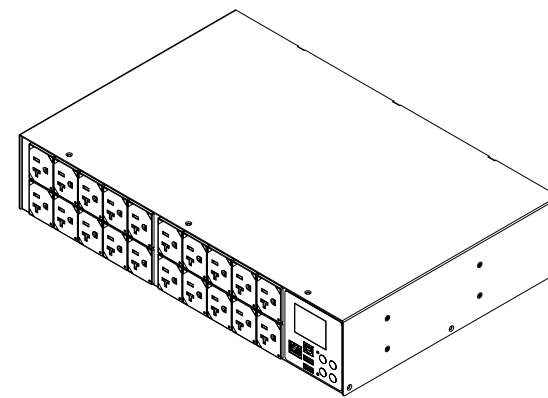

See VIEW B

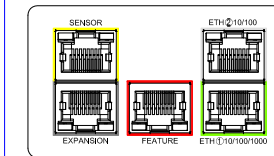

VIEW C

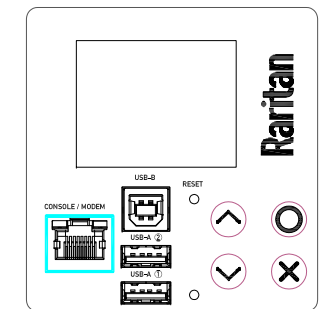

VIEW D

NOTES:

1. INSTALLATION SHALL COMPLY WITH ALL APPLICABLE NATIONAL, STATE AND LOCAL CODES.
2. PLEASE REFER TO PRODUCT DOCUMENTATION FOR FURTHER INFORMATION.
3. UNLESS OTHERWISE SPECIFIED, ALL DIMENSIONS ARE IN MILLIMETERS (INCHES).
4. MOUNTING BUTTON IS AN ALTERNATIVE MOUNTING METHOD TO THE TOOLLESS MOUNT FOR 3RD PARTY ENCLOSURE. BUTTON IS PROVIDED WITH THE UNIT. DETAILED INSTALLATION INSTRUCTIONS CAN BE FOUND IN THE PROVIDED MANUAL.
5. BRACKET KITS TO MOUNT TO SPECIFIC 3RD PARTY ENCLOSURES ARE AVAILABLE AS OPTIONS.
6. LENGTH OF THE CORD IS 3000MM +/- 10MM
7. DIMENSION TOLERANCE: LENGTH +/- 3MM, WIDTH +/- 1MM, DEPTH +/- 0.5MM
8. REFER TO THE TABLE FOR DETAIL CORD LENGTH DEFINITION

Option	Description	Values
A0-A18	Length of the line cord	None: Default (3 Meter) A0=0 Meter (Inlet only, no power cord) A18=0.5 Meter A13=0.6 Meter (2ft) A7=1 Meter A1=1.5 Meter A16=1.8 Meter A2=2 Meter A8=2.5 Meter A14=2.6 Meter A3=3 Meter A9=3.5 Meter A4=4 Meter A5=4.5 Meter A6=5 Meter A15=5.5 Meter A12=6 Meter A11=6 Meter A10=8 Meter A17=10 Meter Note: For inline meters, double Ax will be used, first Ax is for the input cords, and the 2nd Ax is for the output cords.

Raritan.
A brand of **Legrand**

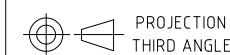

PROJECTION
THIRD ANGLE

DO NOT SCALE DRAWING

SHEET 1 OF 1

Drawing Maker:	EVA LIN	Jan. 19, 2017
Design Engineer:	Kenny_C	Jan. 19, 2017
Approver:	Tom_H	Jan. 19, 2017

THIS DRAWING AND SPECIFICATIONS HEREIN ARE THE PROPERTY OF RARITAN, INC. AND SHALL NOT BE COPIED, REPRODUCED OR USED, IN WHOLE OR IN PART, AS THE BASIS FOR THE MANUFACTURE OR SALE OF ITEMS WITHOUT WRITTEN PERMISSION FROM RARITAN, INC. THIS DRAWING IS BASED UPON LATEST AVAILABLE INFORMATION AND IS SUBJECT TO CHANGE WITHOUT NOTICE.

TITLE: iPDU Two U
Single phase, 16A/100-120V
Inlet Type: IEC60320 C20
Plug Type: NEMA L5-20P
Outlet Type: 5-20R (20)

DWG NO. **PX3-5407R & PX3-4407R**
PX3-5407R-M5 & PX3-4407R-M5

REV. **2A**