

56P332

VIEW A

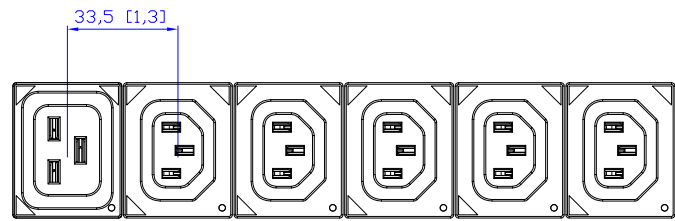

VIEW B

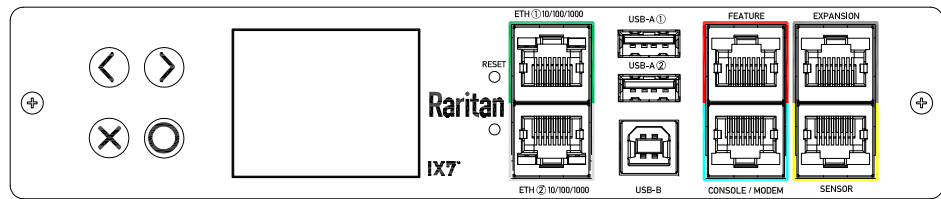

VIEW C

Option 1.

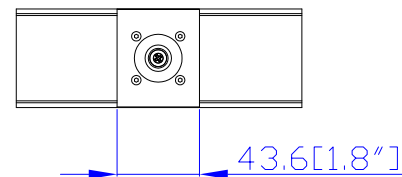
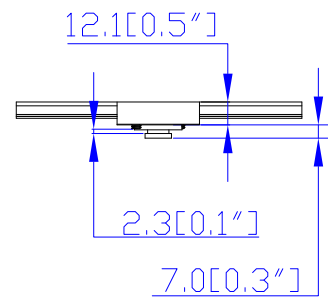

Option 2.

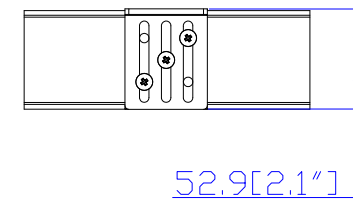
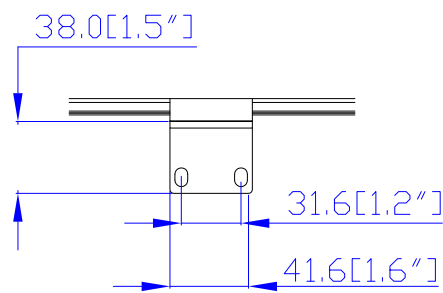

Option 3.

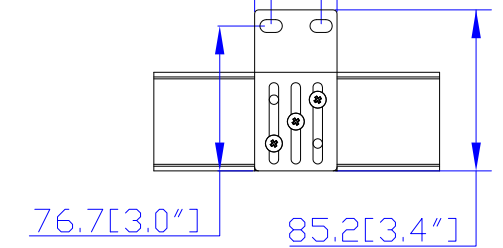
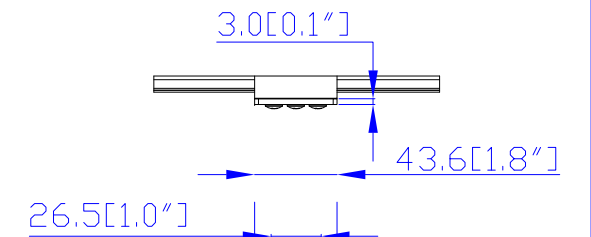

VIEW D

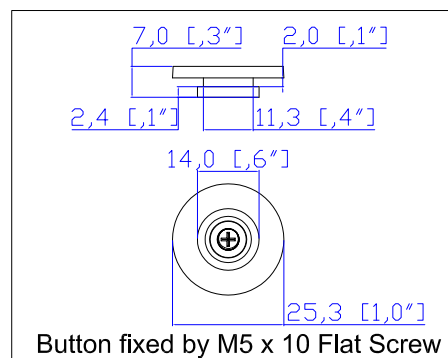
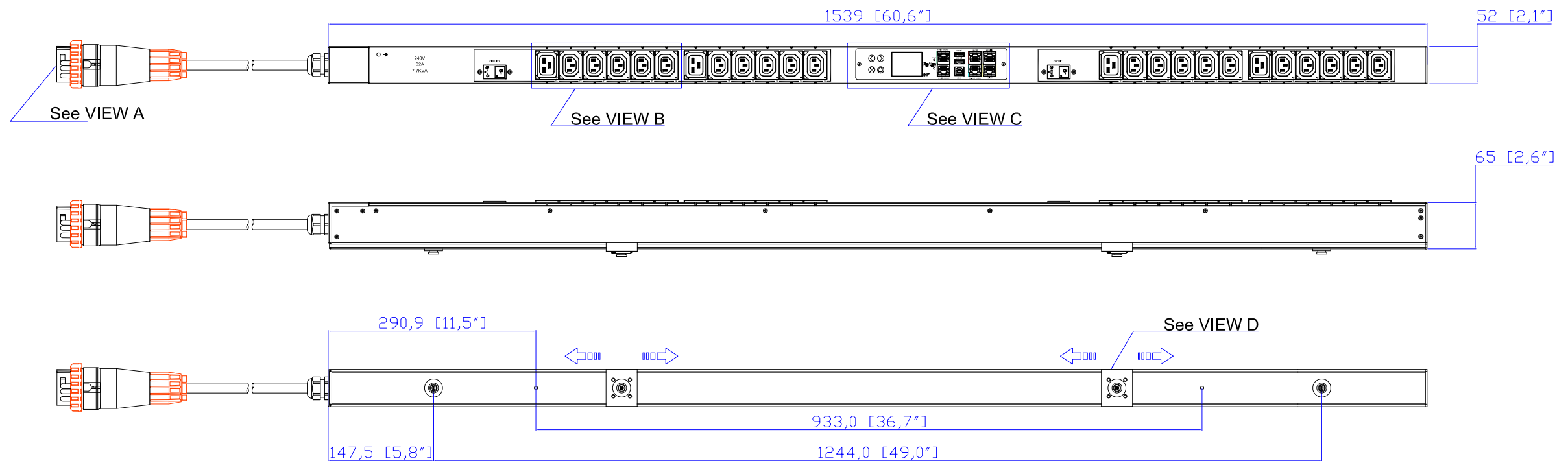

Button fixed by M5 x 10 Flat Screw

NOTES:

1. INSTALLATION SHALL COMPLY WITH ALL APPLICABLE NATIONAL, STATE AND LOCAL CODES.
2. PLEASE REFER TO PRODUCT DOCUMENTATION FOR FURTHER INFORMATION.
3. UNLESS OTHERWISE SPECIFIED, ALL DIMENSIONS ARE IN MILLIMETERS (INCHES).
4. MOUNTING BUTTON IS AN ALTERNATIVE MOUNTING METHOD TO THE TOOLLESS MOUNT FOR 3RD PARTY ENCLOSURE. BUTTON IS PROVIDED WITH THE UNIT. DETAILED INSTALLATION INSTRUCTIONS CAN BE FOUND IN THE PROVIDED MANUAL.
5. BRACKET KITS TO MOUNT TO SPECIFIC 3RD PARTY ENCLOSURES ARE AVAILABLE AS OPTIONS.
6. RARITAN STANDARD LENGTH OF THE CORD IS 3000MM +/-70MM
7. DIMENSION TOLERANCE: LENGTH +/-3MM, WIDTH +/-1MM, DEPTH +/-0.5MM

Raritan
A brand of **legrand**

Drawing Maker: Eva Lin SEP. 25. 2020
Design Engineer: Kenny_C SEP. 25. 2020
Approver: Tom_H SEP. 25. 2020

PROJECTION THIRD ANGLE
DO NOT SCALE DRAWING
SHEET 1 OF 1

THIS DRAWING AND SPECIFICATIONS HEREIN ARE THE PROPERTY OF RARITAN, Inc. AND SHALL NOT BE COPIED, REPRODUCED OR USED, IN WHOLE OR IN PART, AS THE BASIS FOR THE MANUFACTURE OR SALE OF ITEMS WITHOUT WRITTEN PERMISSION FROM RARITAN, Inc. THIS DRAWING IS BASED UPON LATEST AVAILABLE INFORMATION AND IS SUBJECT TO CHANGE WITHOUT NOTICE.

SPECIFICATION

iPDU Zero U
240V, 32A
Plug Type: 56P332
Outlet Type: C13 (20), C19 (4)

DWG. NO.

MPX3-5493A1V M5 & MPX3-4493A1V M5

MODEL NO.

PX3-5493A1V & PX3-4493A1V
PX3-5493A1V-M5 & PX3-4493A1V-M5

REV.

2B