

IEC60309 30A 3PY

VIEW A

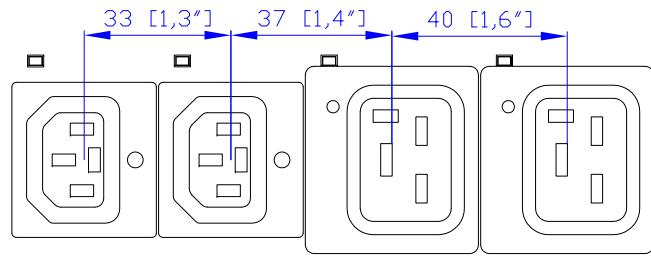

VIEW B

Option 1.

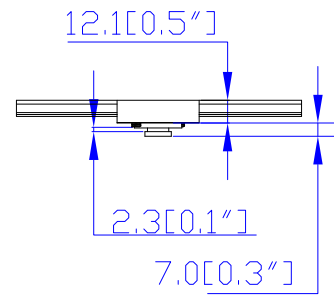

Option 2.

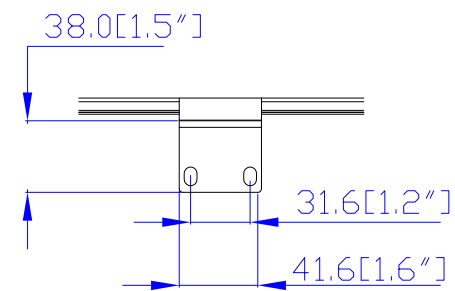

Option 3.

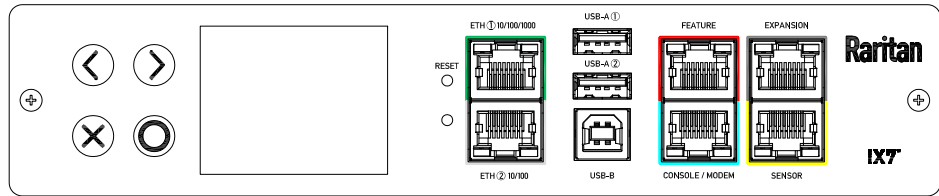
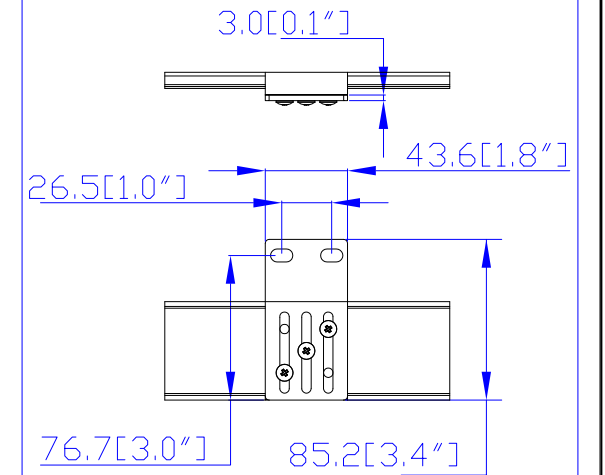

VIEW C

VIEW D

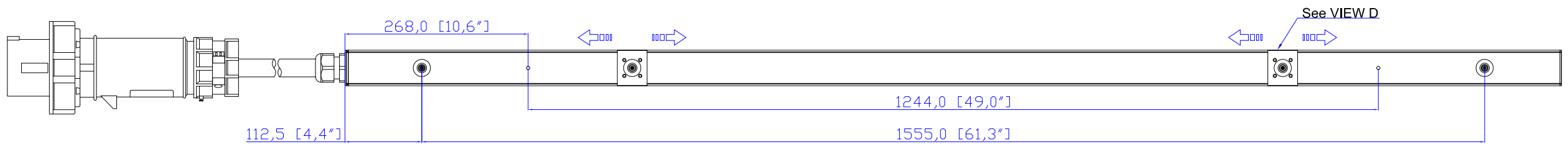
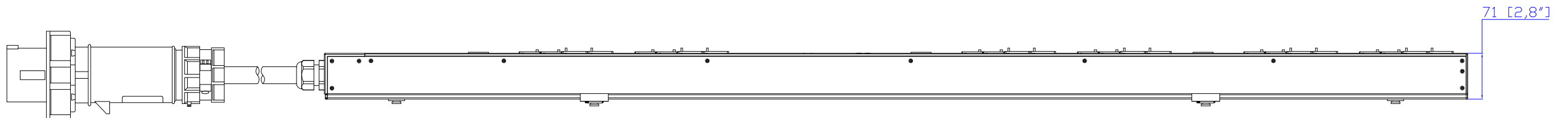
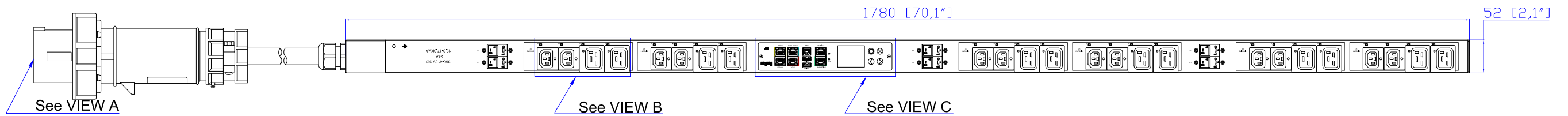

- NOTES
1. INSTALLATION SHALL COMPLY WITH ALL APPLICABLE NATIONAL, STATE AND LOCAL CODES.
 2. PLEASE REFER TO PRODUCT DOCUMENTATION FOR FURTHER INFORMATION.
 3. UNLESS OTHERWISE SPECIFIED, ALL DIMENSIONS ARE IN MILLIMETERS [INCHES].
 4. MOUNTING BUTTON IS AN ALTERNATIVE MOUNTING METHOD TO THE TOOLLESS MOUNT FOR 3RD PARTY ENCLOSURE. BUTTON IS PROVIDED WITH THE UNIT. DETAILED INSTALLATION INSTRUCTIONS CAN BE FOUND IN THE PROVIDED MANUAL.
 5. BRACKET KITS TO MOUNT TO SPECIFIC 3RD PARTY ENCLOSURES ARE AVAILABLE AS OPTIONS.
 6. LENGTH OF THE CORD IS 3000MM +/- 70MM
 7. DIMENSION TOLERANCE: LENGTH +/- 3MM, WIDTH +/- 1MM, DEPTH +/- 0.5MM

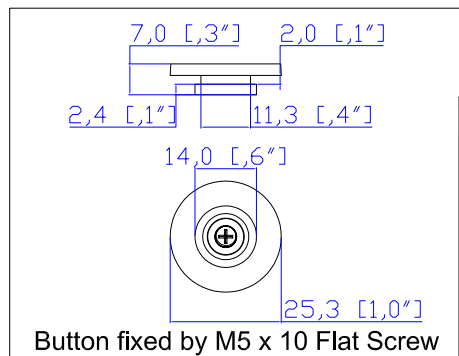

Raritan
A brand of **Legrand**



DO NOT SCALE DRAWING
SHEET 1 OF 1

TITLE: iPDU Zero U
Three Phase, 24A/360-415V
Plug Type: IEC60309 30A 3PY
Outlet Type: Locking C13 (12), Locking C19 (12)

Drawing Maker: Eva_Lin Sep. 20, 2018
Design Engineer: Sam_L Sep. 20, 2018
Approver: Tom_H Sep. 20, 2018

THIS DRAWING AND SPECIFICATIONS HEREIN ARE THE PROPERTY OF RARITAN, Inc. AND SHALL NOT BE COPIED, REPRODUCED OR USED, IN WHOLE OR IN PART, AS THE BASIS FOR THE MANUFACTURE OR SALE OF ITEMS WITHOUT WRITTEN PERMISSION FROM RARITAN, Inc. THIS DRAWING IS BASED UPON LATEST AVAILABLE INFORMATION AND IS SUBJECT TO CHANGE WITHOUT NOTICE.

DWG NO: MPX3-5550IU-E2V2 M5 & MPX3-4550IU-E2V2 M5

MODEL NO: PX3-5550IU-E2V2 & PX3-4550IU-E2V2
PX3-5550IU-E2V2M5 & PX3-4550IU-E2V2M5

REV. **2A**