

VIEW A

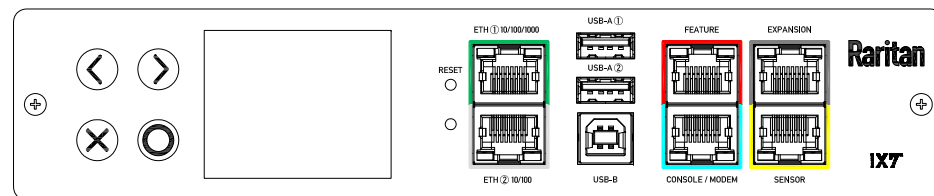

VIEW B

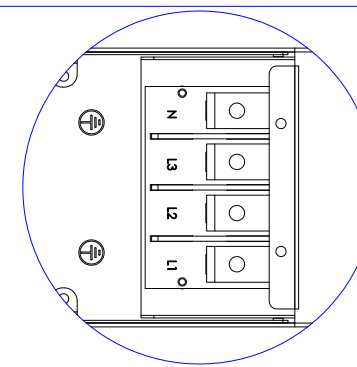

1. KST RNBS 22-6 or equivalent terminals for 4 AWG Wire
2. Inside diameter 6.4 mm & Outside diameter 12.2 mm ring for M6 screw

VIEW C

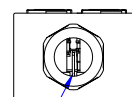
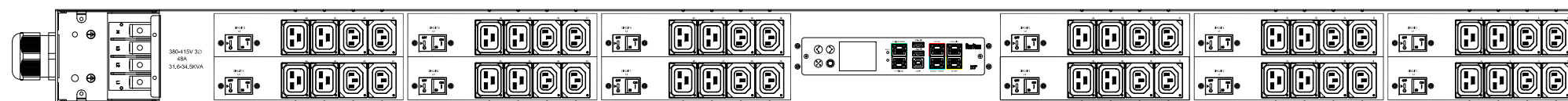
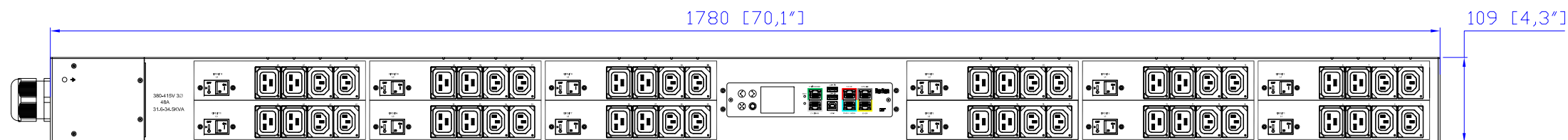

M50 Cable Gland
Assembly Wire Range: 27~35mm

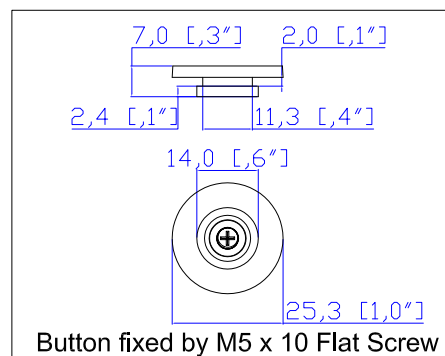
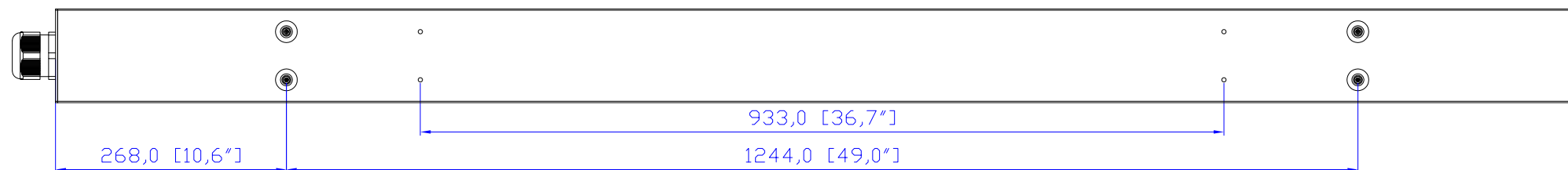

- NOTES:
1. INSTALLATION SHALL COMPLY WITH ALL APPLICABLE NATIONAL, STATE AND LOCAL CODES.
 2. PLEASE REFER TO PRODUCT DOCUMENTATION FOR FURTHER INFORMATION.
 3. UNLESS OTHERWISE SPECIFIED, ALL DIMENSIONS ARE IN MILLIMETERS (INCHES).
 4. MOUNTING BUTTON IS AN ALTERNATIVE MOUNTING METHOD TO THE TOOLLESS MOUNT FOR 3RD PARTY ENCLOSURE. BUTTON IS PROVIDED WITH THE UNIT. DETAILED INSTALLATION INSTRUCTIONS CAN BE FOUND IN THE PROVIDED MANUAL.
 5. BRACKET KITS TO MOUNT TO SPECIFIC 3RD PARTY ENCLOSURES ARE AVAILABLE AS OPTIONS.
 6. LENGTH OF THE CORD IS 3000MM +/- 70MM
 7. DIMENSION TOLERANCE: LENGTH +/- 3MM, WIDTH +/- 1MM, DEPTH +/- 0.5MM
 8. REFER TO THE TABLE FOR DETAIL CORD LENGTH DEFINITION

Raritan
A brand of **Legrand**

PROJECTION THIRD ANGLE
DO NOT SCALE DRAWING
SHEET 1 OF 1

THIS DRAWING AND SPECIFICATIONS HEREIN ARE THE PROPERTY OF RARITAN, Inc. AND SHALL NOT BE COPIED, REPRODUCED OR USED, IN WHOLE OR IN PART, AS THE BASIS FOR THE MANUFACTURE OR SALE OF ITEMS WITHOUT WRITTEN PERMISSION FROM RARITAN, Inc. THIS DRAWING IS BASED UPON LATEST AVAILABLE INFORMATION AND IS SUBJECT TO CHANGE WITHOUT NOTICE.

TITLE: iPDU Zero U
Three Phase, 48A/380-415V
Plug Type: 48A Terminal 3PY
Outlet Type: C13 (24), C19 (24)

DWG NO: MPX3-5956XV M5 & MPX3-4956XV M5

MODEL NO: **PX3-5956XV & PX3-4956XV**
PX3-5956XV-M5 & PX3-4956XV-M5

REV. **2A**

Drawing Maker: Eva Lin Jan. 08, 2017
Design Engineer: Kenny_C Jan. 08, 2017
Approver: Tom_H Jan. 08, 2017