

CEE7/7

VIEW A

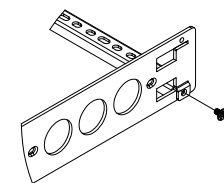
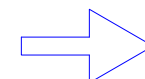
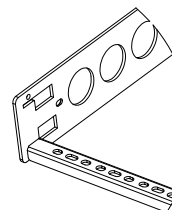
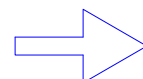
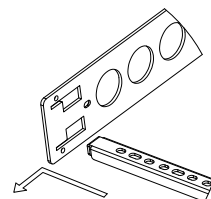
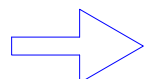
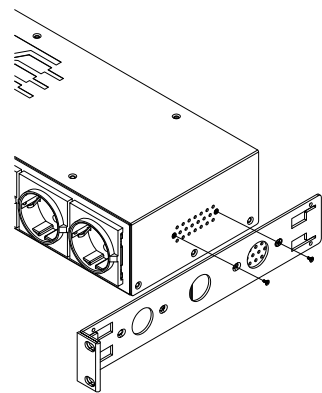

43,6 [1,7"]

253,6 [10,0"]

VIEW B

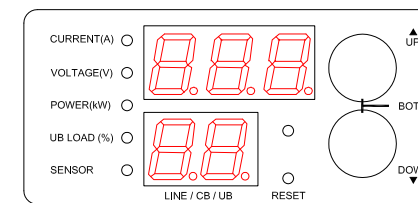

VIEW C

Rear

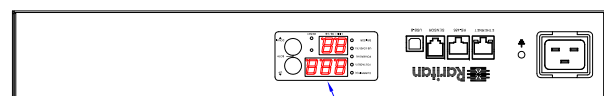

See VIEW C

IEC60320 C19

CEE7/7

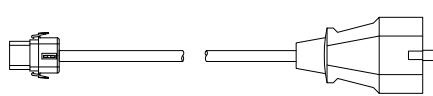

See VIEW A

TOP

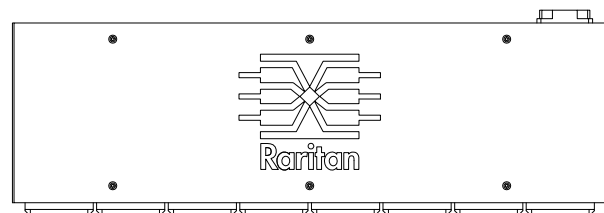

133 [5,2"]

66 [2,6"]

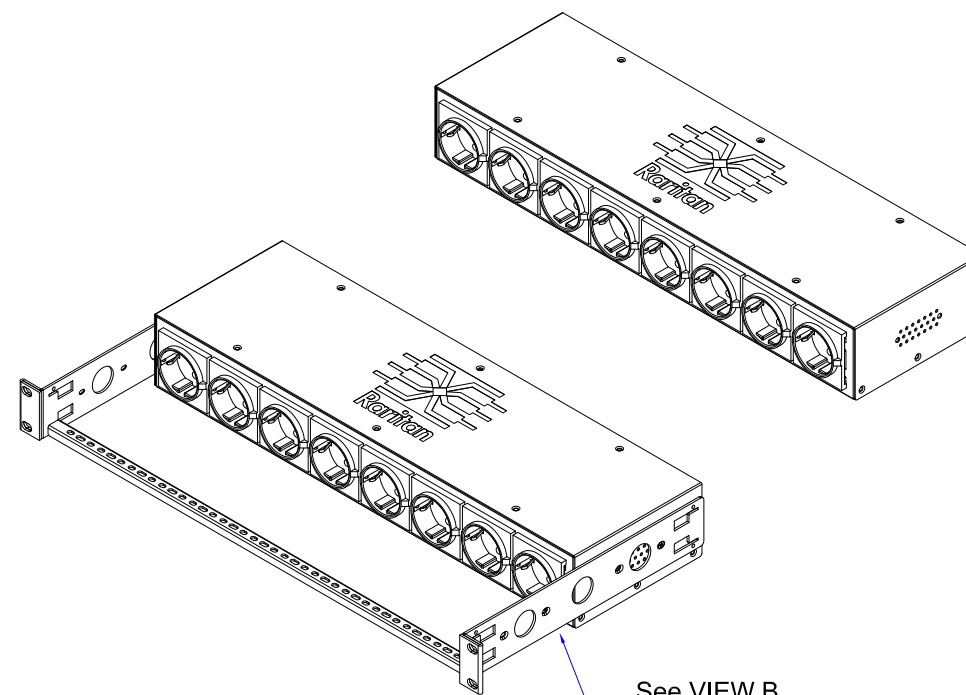

See VIEW B

Front

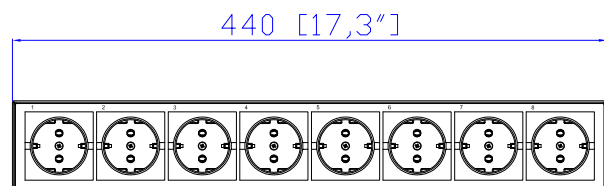

440 [17,3"]

NOTES:  
ALL DIMENSIONS ARE MILLIMETERS[INCHES].



PROJECTION  
THIRD ANGLE

DO NOT SCALE DRAWING

SHEET 1 OF 1

THIS DRAWING AND SPECIFICATIONS HEREIN ARE THE PROPERTY OF RARITAN, INC. AND SHALL NOT BE COPIED, REPRODUCED OR USED, IN WHOLE OR IN PART, AS THE BASIS FOR THE MANUFACTURE OR SALE OF ITEMS WITHOUT WRITTEN PERMISSION FROM RARITAN, INC. THIS DRAWING IS BASED UPON LATEST AVAILABLE INFORMATION AND IS SUBJECT TO CHANGE WITHOUT NOTICE.

TITLE: iPDU 1.5 U  
Single Phase, 16A/200V-240V  
Inlet Type: IEC60320 C20  
Plug Type:CEE 7/7  
Outlet Type: (8)Schuko

DWG NO.

MPXE-1813ER

REV.

0A

Drawing Maker:	Eva LIN	Mar. 28, 2016
Design Engineer:	Siang_H	Mar. 28, 2016
Approver:	Tom_H	Mar. 28, 2016